

The right temperature worldwide

LAUDA



LAUDA Heating and cooling systems

Process cooling systems, Heat transfer systems,
Secondary circuit systems

Heating, cooling,
chilling from
-150 up to 400 °C

LAUDA Heating and cooling systems – Overview

Modular construction and engineering

Temperature control with liquids: **Modules from the LAUDA building kit**

Since our heating and cooling systems are of modular construction, we can individually adapt systems so that our customers achieve optimum performance and end products.

Heat transfer fluids

Heat transfer fluids are primarily differentiated by their possible temperature range. LAUDA will help to select the appropriate heat transfer fluid.

Heat transfer systems

Model series ITH

Model series ITHW

Heat transfer systems use either thermal oil, water or water/glycol as the heat transfer fluid depending on the outflow temperature. They are electrically heated and produce a controlled liquid flow. Heating and cooling systems from the line of heat transfer systems always consist of the electrical heating module and maximum one additional heat exchanger module (cooler). In this design or also in combination with a process cooling system, a heating and cooling system is produced with an extended working temperature range.

Process cooling systems

Model series SUK

Process cooling systems are active cooling systems for the temperature control of different consumer circuits. They have a single-stage cooling circuit or two-stage cascade cooling systems and are water or air-cooled. In combination with an electrical auxiliary heater or a heat exchanger, the SUK model series offers a wide working temperature range. Depending on the application, the most varied heat transfer fluids can be used.

Model series DV

Direct evaporators are special systems for all applications without a heat transfer fluid circuit, e.g. as VOC condensers by direct cooling with the evaporating refrigerant.

Model series KH

Kryoheaters as process cooling systems with an extremely wide temperature range fulfill future requirements on temperature control systems while already offering all the possibilities of the latest in heat transfer fluid technology. They incorporate the chilling technology of the SUK modules – from single-stage compressors to two-stage cascades while at the same time mastering the highest temperature ranges. Kryoheaters are the ideal solution for universal apparatus.

Secondary circuit systems

Model series TR

Secondary circuit systems make use of thermal energy from existing steam, thermal oil, cooling water and cooling brine networks. The control facilitates the automatic extraction of the energy required for heating and cooling from the primary system (via heat exchanger or by the direct injection of the heat transfer fluid).

Model series KP

Kryopac systems are secondary circuit systems. In order to achieve still higher levels of purity in modern production methods, reactions are run at very low temperatures. The range of modules from LAUDA includes the Kryopac system for this application. Here the cooling power of evaporating nitrogen is exploited and transferred to a liquid heat transfer fluid. Many modules in the building kit can also be used in the Kryopac system.

Glossary

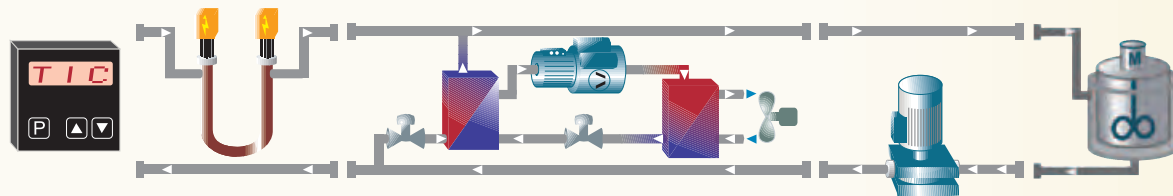

from page 10

-150 °C -110 °C -100 °C -35 °C -20 °C 0 °C 20 °C 100 °C 150 °C 200 °C 280 °C 400 °C

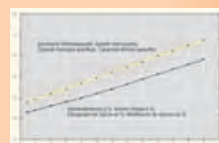
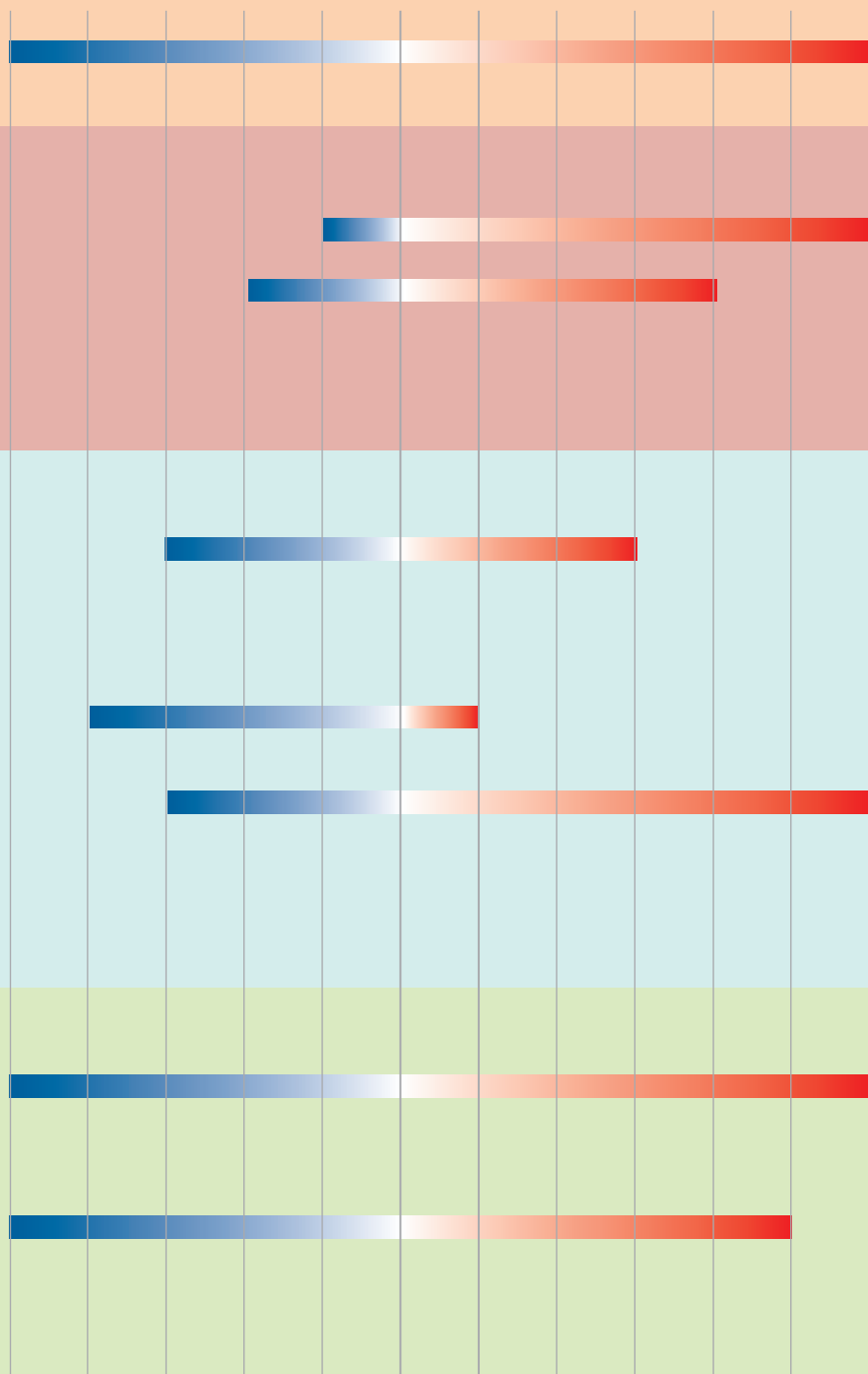

from page 14



from page 16



from page 26



from page 40

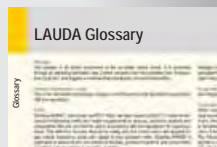

from page 50

Advantages



Fundamental component – competent consultation

At LAUDA you deal with specialists right from the start. We know that the right temperature crucially determines the quality of the end product and our advice is specific to your application. Here we can use our wealth of experience from the numerous systems we have produced. Therefore, we spend much time on this step in the procedure. We have broad knowledge of the field and experience in the project management of technologically demanding systems. Competent consultancy is a basic requirement for successful implementation, timely completion and customer satisfaction.



Connecting element – modular engineering

Project engineering is our special field. Working in close co-operation with you we draw up your specific system in the design process. The keyword here is „modular engineering“. Tried and tested modules, combined for the application, provide you with tailor-made solutions. The matching of desired and actual values demands precise planning and exact project work at all interfaces. Each single LAUDA planning module has been proven many times and is continually developed further. This enables us to guarantee our high quality standard.



Individual systems – highest quality standard

The best design is nothing without dependable implementation. Our production specialists are experienced and know precisely how special customer requirements are realized in heating and cooling systems. Through the on-going qualification of the staff and the implementation of all the relevant standards, all our systems have one thing in common – high quality with excellent performance data. All material qualities and technical features of components are comprehensively documented and can be traced at any time.



Optimal interaction – LAUDA plug & play

Since heating and cooling systems consist of ready-to-assemble units, on site they only need to be connected to the consumer. The transport and siting are already taken into account during the planning. Also questions of installation, pipe routing, insulation, safety engineering and explosion protection have to be clarified beforehand. In this respect LAUDA specialists are right up to date and provide competent support.



Test run – the system is put through its test

Complete system test in the LAUDA test bench before shipment; system with CE label

- Pressure and leakage test (heat transfer fluid system + cooling system according to AD 2000 guideline)
- Functional test under changing load
- Test of control accuracy
- Test run at max. and min. operating temperatures
- Temperature sensor calibration
- Test of all components relevant to safety in line with EC directive
- Test protocol (verification of performance data)



Dependable service – always available anywhere

LAUDA Heating and cooling systems are designed for continuous operation with very little maintenance. However, international regulations and safety directives demand regular maintenance. To cater for the specific requirements preferably a maintenance plan is drawn up specially for the system. Our experienced service technicians carry out regular servicing. We are supported abroad by qualified representatives. The operating body can rest assured that the system is always properly and verifiably safely maintained when the industrial health and safety directive demands recurring inspections. In special cases our service team is available within 24 hours.

Family Company with Tradition

- 1956** Dr. Rudolf Wobser founds the MESSGERÄTE-WERK LAUDA Dr. R. Wobser KG in Lauda in the region of Baden.
- 1964** Birth of the heating and cooling systems for industrial thermostating tasks. Three years later: development of the first tensimeters and film balances.
- 1977** After the death of the father, Dr. Rudolf Wobser, Dr. Gerhard Wobser and his brother Karlheinz Wobser take over the management as partners with unlimited liability.
- 1982** Launch of the world's first mass-produced thermostats using microprocessor technology. Proportional cooling and external control are further sensational inventions.
- 1989** As part of the expansion of the range of products, the MESSGERÄTE-WERK LAUDA is renamed LAUDA DR. R. WOBSEY GMBH & CO. KG.
- 1994** The first circulation chillers of the WK class put an economical end to the wasteful use of precious drinking water as a coolant. A new generation of compact thermostats is introduced. The high quality of all LAUDA products is confirmed upon certification according to DIN ISO 9001.
- 2003** Karlheinz Wobser retires. Dr. Gunther Wobser, part of the company since 1997, is appointed managing partner.
- 2005** On 1st January, the founding of LAUDA France heralds the start of a new age of internationalisation. This first company outside Germany supports the local agencies with customer advice and care.
- 2006** On 1st March, LAUDA celebrates the 50th anniversary of the company. Two months later, LAUDA founds subsidiary LAUDA Wostok in Russia – another milestone in the internationalisation of the company.
- 2008** LAUDA consistently continues the global expansion strategy with the founding of subsidiaries LAUDA America Latina C.A., LAUDA China Co., Ltd. and LAUDA-Brinkmann, LP. USA. With the new production hall plus office building and an investment volume of around 3 million Euro, the heating and cooling systems business unit gains space for additional growth.
- 2009** At ACHEMA, LAUDA presents an equipment showcase. All of the staff from the six foreign LAUDA subsidiaries meet for the first time at the LAUDA World Meeting
- 2010** In March, after more than 32 years, Dr. Gerhard Wobser retires from his function as Managing Director. His son, Dr. Gunther Wobser, assumes his responsibilities.
- 2011** With the founding of the Spanish subsidiary LAUDA Ultracool S.L., LAUDA broadens the product range with industrial process circulation chillers from the "Ultracool" brand.
- 2012** Foundation of subsidiary LAUDA Technology Ltd. in Birmingham, Great Britain.



Managing Director
Dr. Gunther Wobser



Company founder
Dr. Rudolf Wobser



Karlheinz Wobser

Dr. Gerhard Wobser

LAUDA, Ultra-Kryomat, Kryomat, LAUDA Vario pump and iVisc are registered trademarks of the LAUDA DR. R. WOBSEY GMBH & CO. KG

With more than 380 employees, more than EUR 65 million in annual turnover and eight foreign subsidiaries, LAUDA is the global leader in the manufacture of innovative thermostatic equipment and systems for science, application technology and production, as well as for high-quality measuring devices. With more than 50 years of experience and a unique product portfolio ranging from compact laboratory thermostats to industrial circulation chillers to customised heating and cooling system projects with more than 400 kilowatts of cooling power, LAUDA is the only company that can guarantee optimized temperature throughout the entire value-added chain for its 10,000 plus customers worldwide.

Quality products from LAUDA keep temperatures constant to an impressive 5 thousandth °C or make targeted changes in an area spanning -150 to 400 °C. Through active cooling or warming, production processes are accelerated or, indeed, made possible in the first place. In such cases, LAUDA, for example, replaces the uneconomical mains-water cooling with environmentally friendly and cost-efficient devices or, alternatively, uses existing forms of primary energy such as thermal discharge. LAUDA measuring instruments determine the surface tension, tension limit and viscosity of liquids precisely.

As a highly specialised niche provider, LAUDA ranks either first or second in almost all future-oriented sectors. In the semi-conductor industry, all the renowned manufacturers and suppliers place their trust in LAUDA thermostats and heating and cooling systems. LAUDA quality products also enable both the research and mass production of vital medicines. In the growing medical technology market, circulation chillers made by LAUDA cool patients and guarantee safe open-heart surgery. LAUDA industrial circulation chillers provide reliable and cost effective cooling for printing machines, injection moulding plants and laser processing machines. Further principle applications include material inspection, biotechnology and the cooling of laboratory instruments and machines. LAUDA thermostats are, naturally, also used in the measuring instruments manufactured by us. For example, in order to determine the viscosity of aviation fuel under real conditions at 10,000-meter altitude, the sample is cooled in the laboratory down to -60 °C.

Through numerous innovations and ongoing investment, LAUDA is sustainably improving its excellent market position and is growing both in the main European market as well as overseas.

LAUDA – The right temperature worldwide



Industrial safety in all weathers: LAUDA container systems – the outdoor solution



LAUDA SUK 1000 L process cooling system in a container

LAUDA is extending its range of modular heating and cooling systems (HKS) with a weather-proof cover. HKS container systems are always in demand when medium to high-power thermostatic control applications are needed and the equipment is positioned outside of the building. The container itself is thermostatically controlled and therefore withstands various climatic conditions.

Apart from this advantage noise control or the avoidance of Ex-protection areas may be reasons for a container solution. For such isolated applications outside the building often only simplified or even no approval procedures are necessary. With the interior fittings of the container LAUDA is just as flexible as with other heating and cooling systems. Here, LAUDA draws on the well-proven modular system. Principally, all modules can be used within the container.

The containers are completely assembled and are tested in all operating states in the factory test rig. Once delivered, the system only has to be connected and can be put into operation immediately. A genuine plug & play solution from LAUDA.

Face-lift in compact control systems: LAUDA Control Module SR 600/SR 601



Digital controller SR 600/SR 601

High accuracy over the complete temperature range is also true for the continually increasing demands from process technology.

In terms of control quality and operational safety the control system, SR 600/SR 601, follows its successful predecessor the SR 500/SR 501 series.

External or manual set-points or set-point curves (in the gradient mode or with the integrated programmer) can be used as in a pure outflow temperature controller (SR 600) and also in a cascade configuration and for product temperature control (SR 601).

More powerful features such as Delta T limiting of the temperature difference between product and outflow, outflow and return or manipulated-variable limitations facilitate a larger number of configurations which integrate the control system even better into the overall process.

Variable PID parameter sets, different limits and a greater number of limits as well as various interface configurations (Profibus DP, Modbus, Ethernet, RS 485, RS 232) fulfill almost any customer requirement.



Order the LAUDA Ultracool brochure for industrial chillers free of charge. This and additional product information can also be found in the download area at: www.lauda.de



Intelligent monitoring: LAUDA PLS – process optimized control

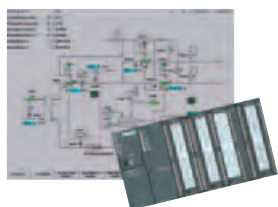

Programmable controller in the Siemens S7 series with an example of process visualization

In complex systems it may be necessary to have feedback for each sensor and actuator. Using logical gating of the inputs and outputs, operational phases can be precisely initiated. It goes without saying that the system is also intelligently monitored.

Varying filling levels or operating quantities are recorded and produce an alarm even before a fault occurs.

This is a huge plus point, particularly where high demands are made on operational safety. The intelligent Siemens S7 variant also scores on the subject of maintenance and service. Continuous leakage monitoring on cooling systems is also provided and operating states are stored on a data logger so that they can be recalled by remote diagnosis. Operation and visualization occurs using a modern touch screen which is also available in an explosion-protected version. With control and communication over bus systems the S7 really reveals its strengths.

The right concept for exacting demands and complex temperature control tasks – a **LAUDA process-optimized solution**.

LAUDA – much more than heating and cooling systems

The right temperature worldwide and the highest precision – at LAUDA these claims also extend to high-quality constant temperature equipment and intelligent measuring instruments.

LAUDA Measuring instruments

Viscometers and tensiometers from LAUDA are essential for the analysis of polymers, oils, greases and tensides. With the modular concept of the PVS process viscometer, measuring routines can be conducted effectively, quickly and safely and repeated as desired. The LAUDA iVisc capillary viscometer is new, space-saving, fully automatic and easy to operate. With LAUDA tensiometers, it is possible for example to determine the exact interfacial surface tension of transformer oils. Countless measuring instruments have long been used in the food and beverage industries, in petrochemistry, by tenside manufacturers and in pharmacy.



LAUDA Constant temperature equipment



For more than 50 years LAUDA has been designing and manufacturing high-quality constant temperature equipment in an operating temperature range from -90 up to 400 °C. Starting with water baths through to high-performance process thermostats. For routine tasks the economically priced LAUDA Alpha heating

and cooling thermostats are the first choice. The new product line ECO and Proline thermostats enable professional and, at the same time, economical temperature control. High cooling outputs and fast cooling rates are offered by the Proline Kryomats. The more powerful Integral T and Integral XT process thermostats provide a lightning-fast temperature change with external temperature control. The LAUDA Ultracool industrial circulation chillers with a cooling output of up to 265 kilowatts and a working temperature range from -5 up to 25 °C are used by the manufacturers of, for example, printing machines, injection moulding plants and laser processing machines. LAUDA thermostats are characterized by excellent handling, high ergonomics and intuitive operation.

Subsidiaries

- LAUDA headquarters in Germany
- Worldwide subsidiaries



LAUDA. The right temperature worldwide.

Our subsidiaries.

- LAUDA-Brinkmann, LP**
Constant temperature equipment
Measuring instruments
Heating and cooling systems
Service
1819 Underwood Boulevard
08075 Delran, NJ
USA
North America
Phone: +1 856 7647300
Fax: +1 856 7647307
E-mail: info@lauda-brinkmann.com
Internet: www.lauda-brinkmann.com
- LAUDA Ultracool S.L.**
Constant temperature equipment
Measuring instruments
Service
C/ Colom, 606
08228 Terrassa (Barcelona)
Spain
Phone: +34 93 7854866
Fax: +34 93 7853988
E-mail: info@lauda-ultracool.com
Internet: www.lauda-ultracool.com
- LAUDA China Co., Ltd.**
Constant temperature equipment
Measuring instruments
Heating and cooling systems
Service
17C, Zaofong Universe Building
No. 1800 Zhong Shan Xi Lu Xuhui
District
200235 Shanghai
China
Phone: +86 21 64401098
Fax: +86 21 64400683
E-mail: info@lauda.cn
Internet: www.lauda.cn
- LAUDA America Latina C.A.**
Constant temperature equipment
Measuring instruments
Service
Ave. Las Americas, Urb. El Rosario
Residencias Agua Santa, Apt. PH-A
5101 Merida
Venezuela
Latin America
Phone: +58 274 4164466
Fax: +58 274 2666912
E-mail: markus.mueller@lauda.com.ve
Internet: www.lauda.com.ve
- LAUDA France S.A.R.L.**
Constant temperature equipment
Measuring instruments
Heating and cooling systems
Service
Parc Technologique de Paris Nord II
Bâtiment G
69, rue de la Belle Etoile
BP 81050 Roissy en France
95933 Roissy Charles de Gaulle Cedex
France
Phone: +33 1 48638009
Fax: +33 1 48637672
E-mail: info@lauda.fr
Internet: www.lauda.fr
- LAUDA Singapore Pte. Ltd.**
Constant temperature equipment
Measuring instruments
Service
24 Sin Ming Lane #03-98
573970 Midview City
Singapore
Phone: +65 65703995
Fax: +65 65703887
E-mail: info@lauda.sg
Internet: www.lauda.sg
- LAUDA Technology Ltd.**
Constant temperature equipment
Measuring instruments
Heating and cooling systems
Service
4200 Waterside
Solihull Parkway
Birmingham Business Park
B37 7YN Birmingham
Great Britain
Phone: +44 121 7174789
Fax: +44 121 7174729
E-mail: info@lauda-technology.co.uk
Internet: www.lauda-technology.co.uk
- OOO „LAUDA Wostok“**
Constant temperature equipment
Measuring instruments
Heating and cooling systems
Service
Malaja Pirogowskaja Str. 5
119435 Moscow
Russia
Phone: +7 495 9376562
Fax: +7 495 9337176
E-mail: alexey.morozov@lauda.ru
Internet: www.lauda.ru

LAUDA cooperates with various representatives around the world. Thoroughly trained and highly qualified employees in sales and service of our representatives give friendly and competent advice to our customers worldwide. Please refer to www.lauda.de for detailed contact data of your local LAUDA representative (sector: Company → Worldwide).

Modular construction

Technical ideas and innovations are standard features at LAUDA. Furthermore, LAUDA offers economical and customized solutions with well-honed project engineering and a comprehensive range of heating and cooling systems – exactly matched to specific applications. Single modules, successfully proven and tested in practice, are configured to form an adaptable building kit. Since modern technologies in the manufacture of different products are demanding increasingly wide temperature ranges, systems

are now operated, almost seamlessly, with one heat transfer fluid – that is, without any switch-over. It is only when the plant, process and thermostatic system are matched to one another that process times and energy input are minimized. Temperature control systems must also be integrated „seamlessly“ into the process control engineering. This is the way to obtain the decisive conditions for high-quality end products – one of the most important prerequisites for a comprehensive process validation.

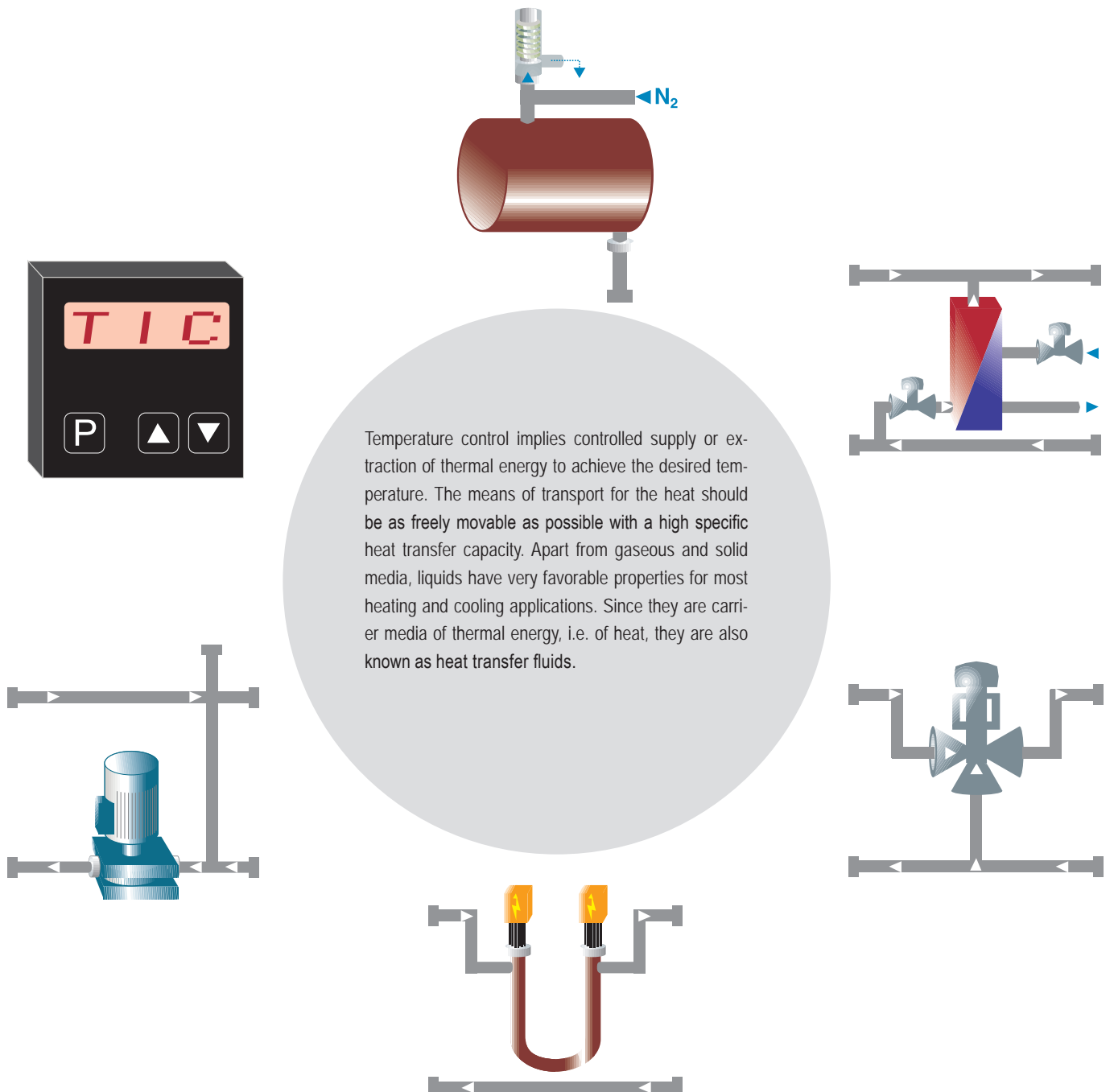

Elementary parts with a system – the individual solution for your plant

The requirements on temperature control systems with regard to temperature stability, flexibility, automation and environmental compatibility are becoming increasingly stringent. Consequently, modern heating and cooling modules must be expandable, modifiable and combinable. In comparison to conventional systems (central single fluid systems of the 80s/90s) decentralized modules can be adapted more flexibly to modern production requirements.

An important aspect for calibration and qualification of a system is, for example, independence. Influences from central energy networks can have a negative effect on the availability of temperature control modules. Therefore, the temperature requirements of one system affect the input parameters of all the others.

It is only through a decentralized concept that increased requirements can be fulfilled in relation to reproducible control results. This represents a logical development in the world of qualifiable thermostatic control.

At LAUDA, all modules are manufactured as standard units using in-house production. The immediate vicinity of project engineering, production, test and service departments is one of LAUDA's special strengths.

For over 50 years LAUDA has been building and qualifying temperature control systems within a unique scope from -150 up to 400 °C and the company leads the field in terms of reliability, service life, control accuracy and quality. Furthermore, LAUDA is also a competent partner in all aspects of explosion protection, plant technology and plant safety.



Modular construction of temperature control systems – here in the production center at Nycomed, Singen, Germany

Draw up your system design with the LAUDA module configurator at www.lauda.de

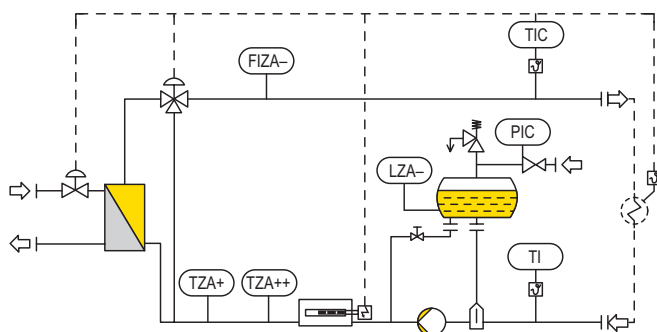

Schematic representation of a compact heat transfer system with heat exchanger (cooler) for decentralized installation

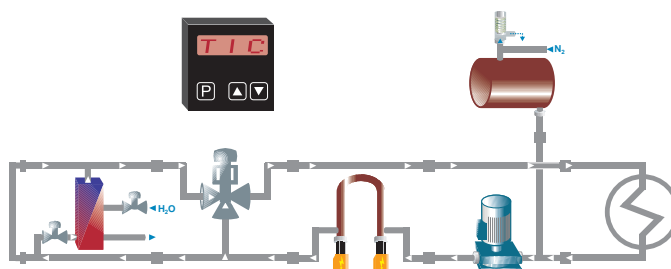

Modular representation of the heat transfer system; all modules are interchangeable and expandable

Basic modules – Supplementary modules – Heat exchanger modules

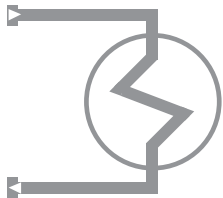

Consumer

The control result depends on the object to be controlled. The control circuit consists of the consumer and the LAUDA temperature control system. The mass, thermal coupling and distance (pipework) determine the subsequent control quality. These points need to be considered right at the design stage.

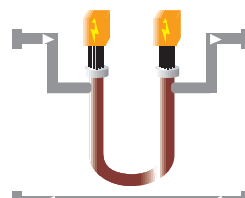

Electric heater

Electric heaters are always used when heating by steam or other media is not possible or only possible up to a temperature which is too low. For energy-saving reasons a combination with second form of heating is however interesting.

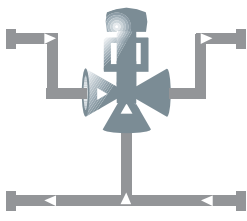

Three-way valve

Particularly, when stable control is required, the three-way valve is able to precisely mix two flows. Only one actuating controller is needed for this, in contrast to solutions with complex valve switching. Due to the hydraulic balance of the two flows, the pressure levels and volume flow rates remain stable – as does the closed-loop control characteristic in difficult partial load operation.

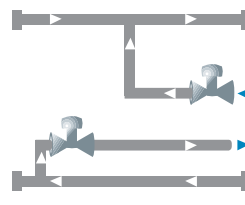

Direct media coupling

If the same medium is used in the primary system as in the secondary circuit, direct coupling without a heat exchanger may give energy advantages. When the production of low temperatures is involved, each degree counts. The expansion tank is not needed, so this makes the unit more economical and more compact.

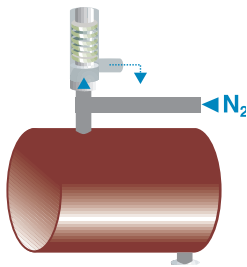

Expansion tank

Expansion tanks can be open to the atmosphere, pressurized, rendered inert or also realized as diaphragm chambers. The design, size and materials are specified appropriately as required.

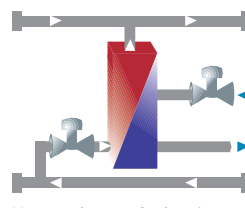

Heat exchanger for heating or cooling with liquid media

Heat exchangers are used when the heating and cooling energies of different media are to be exploited. With intelligent controllers the system efficiency can be further increased by heat and cold recovery.

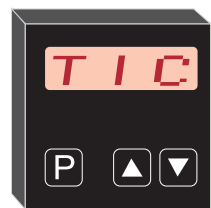

Controller

Temperature control means processing without temperature variations as well as controlling temperature progression. In the second case the temperature control system must be able to track certain curves. The LAUDA SR 600/SR 601 control module acquires set point and actual-value data and facilitates very precise control results in the cascade mode. Also, compliance to certain maximum temperature differences is freely adjustable.

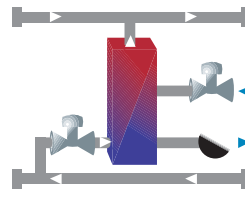

Heat exchanger for heating with steam

Media containing chlorides are very corrosive. Here, special materials have to be used. High pressure steam demands a different heat exchanger design, as does deep-chilled thermal oil or liquid nitrogen. Therefore, the type of construction, materials, operating conditions and usable heat transfer area are specified differently from case to case.

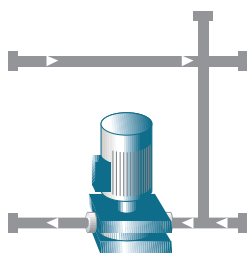

Pump

Pumps are responsible for the circulation of the heat transfer fluid. In the selection of the right pump the following points play an important role: the conveying medium, temperature range, type of construction and, where applicable, the operating body's inventory. The pump flow is always ensured via the three-way valve.

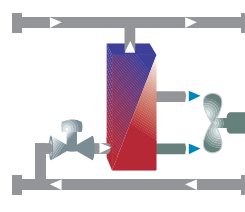

Heat exchanger for heating or cooling with air

It is worth using existing sources of cold and heat. For example, an air-cooled thermal-oil heat exchanger exploits the cooling power of the ambient air, is used for heating purposes in winter and preserves the environment. Also, river water or a cooling tower may be interesting alternatives to the cold water network which must be expensively recooled. Here too, heat exchangers help to save energy costs.

Air-cooled refrigeration modules

Single-stage cooling system with air-cooled condenser for producing temperatures from -35 up to 20 °C. The system consists of a single-stage compressor, evaporator, condenser, control components and a lubricating oil system.

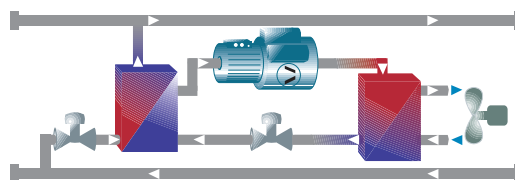

Cooling system with single-stage compressor, air-cooled

Single-stage cooling system with air-cooled condenser for producing temperatures from -50 up to 20 °C. The system consists of a two-stage compressor, evaporator, condenser, control components and a lubricating oil system.

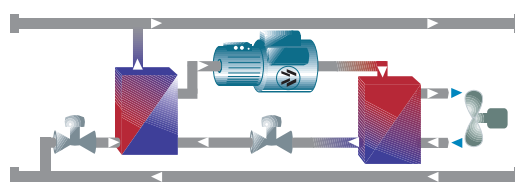

Cooling system with two-stage compressor, air-cooled

Two-stage cascade cooling system with air-cooled condenser for producing temperatures from -100 up to 20 °C. This system consists of two compressors, an evaporator, condenser, intermediate heat exchanger, control components and a lubricating oil system for each compressor.

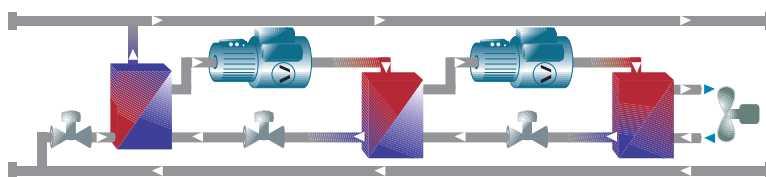

Two-stage cascade cooling system, air-cooled

Water-cooled refrigeration modules

Single-stage cooling system with water-cooled condenser for producing temperatures from -35 up to 20 °C. The system consists of a single-stage compressor, evaporator, condenser, control components and a lubricating oil system.

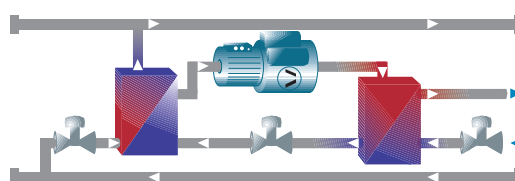

Cooling system with single-stage compressor, water-cooled

Single-stage cooling system with water-cooled condenser for producing temperatures from -50 up to 20 °C. The system consists of a two-stage compressor, evaporator, condenser, control components and a lubricating oil system.

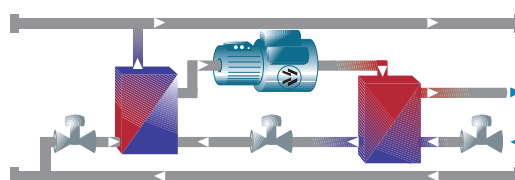

Cooling system with two-stage compressor, water-cooled

Two-stage cascade cooling system with water-cooled condenser for producing temperatures from -100 up to 20 °C. This system consists of two compressors, an evaporator, condenser, intermediate heat exchanger, control components and a lubricating oil system for each compressor.

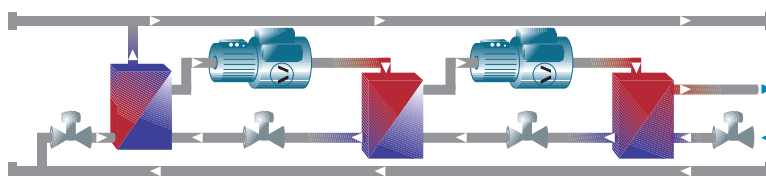

Two-stage cascade cooling system, water-cooled

Heat transfer fluids

Tips on the selection of a suitable heat transfer fluid

Nothing is more important than the right concept for selecting the optimum temperature control system. Firstly the temperature range must be defined for the application under consideration. In this respect some details about the process and the plant equipment should already be known. The maximum and minimum heat transfer fluid temperatures are not only given by the temperature progression of the actual process, but rather the relevant power balance, type and geometry of the plant equipment primarily determine the required temperature differences on the heat transfer surfaces. These temperature differences are needed for the heat transfer

and therefore the temperature range of the heat transfer liquid must be correspondingly wider, both upwards and downwards. Then, the question of the heating or cooling source must be clarified. Is an existing medium to be used by means of a heat exchanger in a secondary circuit system for heating and cooling or is a heat transfer system with electrical heating or a process cooling system with chillers required? Irrespective of which modules are used to customize the system, it belongs to one of the three LAUDA lines of systems.



LAUDA Heating and cooling systems are essentially closed systems. Through the connection of compressed air or nitrogen, pressurization and inertization (nitrogen) can be realized. In this way the heat transfer fluids can be used in essentially wider temperature ranges than with open systems (without pressurization).

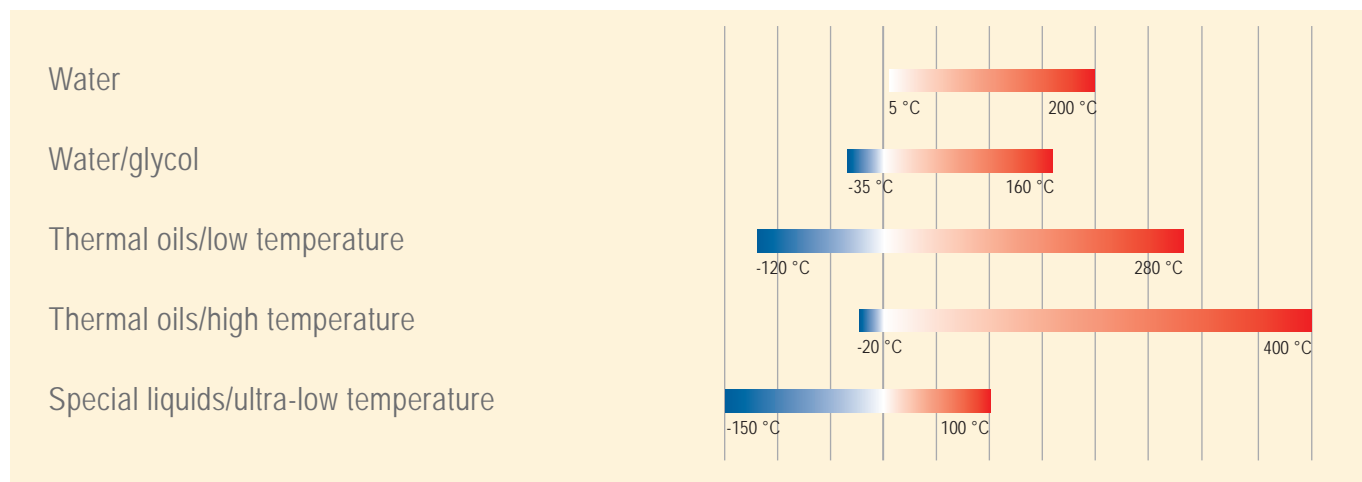

Heat transfer fluids are primarily differentiated by their possible temperature range. Water is the most popular and most frequently used thermostatic medium. With regard to the high specific thermal capacity of nearly 4.2 kJ/kgK water is the best possible heat carrier. Through addition of an anti-freeze agent, e.g. glycol, the temperature range can be expanded down to -35 °C. However,

the high vapor pressure above 100 °C is often a disadvantage of aqueous heat transfer fluids. To be able to obtain temperature ranges between -120 and 400 °C organic heat transfer liquids or silicone oils must be used. If evaporation without residues is important, e.g. sensitive electronic components have to be thermally tested, fluorine-based inert liquids can also be used.

Tips on the use of a suitable heat transfer fluid

Heat transfer fluids are taken to be liquids which supply energy to and remove it from the consumer. The heat transfer fluid is transported to the consumer by the circulating pump on the thermostatic system. The larger the circulating flow rate of heat transfer fluid (for the same power), the less the temperature difference will be, measured between the inlet and outlet on the consumer. The less the temperature difference, the better the control accuracy.

In industry organic heat transfer fluids in numerous variants are available. It is to be checked in each individual case whether a medium is suitable for the specific application, particularly with regard to the maximum operating temperature, the viscosity in the cold state and the vapor pressure.

All organic heat transfer fluids under consideration should not come into contact in the hot state with oxygen, because the service life of the heat transfer fluid will be substantially reduced. At low temperatures there is the risk of water formation. Consequently, all LAUDA systems have a cold oil blanket in the separate expansion tank with a temperature in continuous operation between ambient temperature and maximum 100 °C. The condensation of water vapor can be effectively prevented by a nitrogen blanket.

Furthermore, interactions with materials of the plant equipment or substances in the process must be considered. Flammability, toxicity, shelf life and local regulations are further selection criteria. The economical aspect should, of course, also not be neglected. The range of technical heat transfer fluids varies widely and is being continually expanded. LAUDA will help in making the right selection.

If, however, the heat energy is to be transferred from one liquid to a second liquid through a wall separating the two liquids, then this is said to be heat transmission, e.g. heat transfer in a heat exchanger.



For optimum heat transfer the following criteria should be satisfied:

- High boiling point or boiling range
- Low solidification temperature
- Good heat transfer properties
- Low viscosity in the temperature range employed
- Good thermal stability
- Low fire hazard (high flash and fire points)
- Low tendency to corrosion when in contact with the plant-equipment materials
- Low sensitivity to extraneous materials (e.g. oxygen)
- Non-toxic with no obnoxious odors

The following standards provide information:

- DIN 4754
Heat transfer installations working with organic heat transfer fluids - Safety requirements, test
- DIN 51522
Heat transfer fluids Q - Specifications, test
- DIN 51529
Testing of mineral oils and related products – Test and assessment of used heat carrier media
- VDI 3033
Heat-transfer systems with organic heat-transfer media - Operation, maintenance and repair

Safety regulations

There are special safety regulations for different heat transfer fluids. The specifications of a heat transfer fluid are described in the so-called safety data sheets which are put at your disposal by LAUDA on request.



LAUDA will recommend suitable heat transfer fluids on request

LAUDA ITH Heat transfer systems

The universal systems up to 400 °C



Application examples



- Temperature control of stirrer tanks
- Temperature control of reactors in chemistry, pharmaceuticals and biotechnology
- Environmental simulation, automotive and solar technology
- Use in materials testing, research and production
- Temperature control of heat exchangers and evaporators

Reliable, safe, individual

LAUDA Heating and cooling systems from the line of heat transfer systems in the ITH model series always consist of the electrical heating module, circulating pump, expansion tank and a maximum of one heat exchanger module (cooler). The systems can be equipped with a water, brine or air-cooled heat exchanger. If a cooling oil

network is available, the heat transfer fluid can be directly coupled. The heat exchanger and expansion tank are then omitted. The systems produce a temperature controlled liquid flow and are supplied as compact, completely insulated, ready-to-use systems with a control cabinet. They are fully tested at the factory.

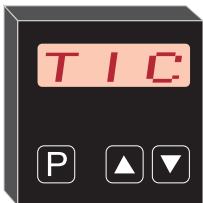
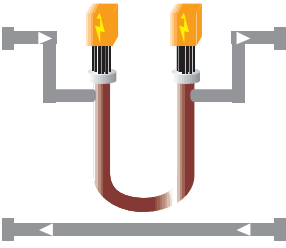
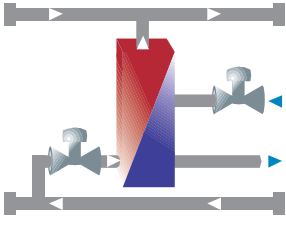
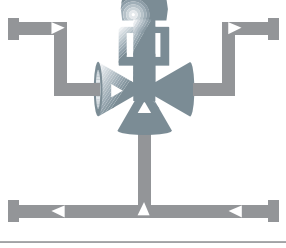
Your advantages at a glance

+	The ITH advantages	Your benefits
	<ul style="list-style-type: none"> • Digital temperature controller 	<ul style="list-style-type: none"> • Control of the outflow temperature or the consumer/product temperature • Temperature program/ramp mode • External setpoint adjustment via Profibus, Modbus or other interfaces • Preselection of heating and cooling times • Control accuracy ± 0.1 °C
	<ul style="list-style-type: none"> • Continuously controlled stainless steel electric heater as a flange version 	<ul style="list-style-type: none"> • Low film temperatures • Low surface loading • Long service life of thermal oil and heating elements • Low pressure loss • Heating power is adapted to actual energy requirement
	<ul style="list-style-type: none"> • Water, brine or air-cooled plate heat exchanger in stainless steel or shell and tube heat exchanger in flange version • Hermetic version without seals • Automatic shut-off valve on cooling water inlet • Return temperature limit on cooling water 	<ul style="list-style-type: none"> • Easy heat exchanger replacement • Oils and water are not mixed • Contamination of heat exchanger avoided • Corrosion and calcification avoided
	<ul style="list-style-type: none"> • Three-way control valve with bellows and actuator in flange version • Stepless temperature control • Limitation of the cooling mediums' return temperatures 	<ul style="list-style-type: none"> • Stabilization of minimal cooling powers • Due to bypass operation, no steam hammering in heat exchanger • Gentle cooling • No thermostatic changeover in the heat exchanger on switching from cooling to heating
	<ul style="list-style-type: none"> • Complete system test in LAUDA Test Bed before shipment; system with CE label • Functional testing of all components and checking of all set values • Pressure/leakage test with the heat transfer fluid • Test of control cabinet and control accuracy • Production of a test protocol; documentation of the tests carried out • FAT (Factory Acceptance Test) in presence of customer 	<ul style="list-style-type: none"> • Hot and cold runs with the heat carrier at maximum and minimum operating temperatures • Systems quickly ready for operation, short commissioning times • Avoidance or prevention of leakage • Verification of control accuracy and high-precision processes • Check of all performance verifications • Systems designed to customer requirements, initial instruction and trial run already before shipment

ITH Heat transfer systems with thermal oil

Electrically heated thermal oil systems are preferably used when a consumer is to be heated or temperature controlled at high operating temperatures and low pressures. These systems are simple and quick to install and need only a slight amount of maintenance. If they are also equipped with a heat exchanger (cooler), a ready-to-use heating and cooling system is produced.

Thermal oil is the ideal heat transfer fluid in the high temperature range. Due to the large operating temperature range, the systems are very flexible in use. There is no corrosion hazard or risk of freezing, thus simplifying siting outdoors.



Heat transfer system ITH 600

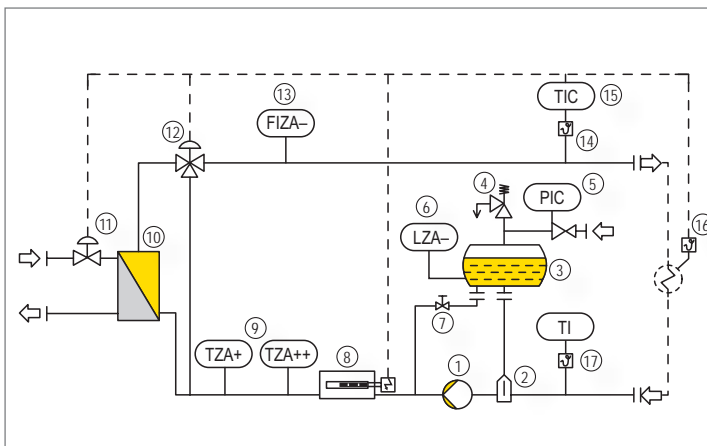

Standards and guidelines considered

- DIN 4754 (Heat transfer systems working with organic heat transfer fluids)
- PED 97/23/EC (Pressure Equipment Directive)
- 2006/42/EC (Machinery Directive)
- 2006/95/EC (Low Voltage Directive)
- AD 2000 (Technical regulations for pressurized vessels and pipes)
- 2004/108/EC (EMC Directive)
- 94/9/EC (Guide on explosion protection for machinery - ATEX)

Through modular design

- Expandable
- Modifiable
- Combinable
- Safety equipment with tested components
- Calibrated temperature probe
- Calibrated PID temperature controller with programmer and display for ramp mode
- Control cabinet on the units or mounted separately
- Internal or external expansion tank

- ① Circulating pump
- ② Air/gas separator
- ③ Expansion tank
- ④ Safety valve
- ⑤ Pressure controller
- ⑥ Level monitoring
- ⑦ Boil-out valve
- ⑧ Electric heater
- ⑨ Temperature monitoring
- ⑩ Heat exchanger, „Cooling“
- ⑪ Valve, „Cooling“
- ⑫ Three-way valve
- ⑬ Flow monitoring
- ⑭ Temperature probe, „Outflow“
- ⑮ Temperature controller
- ⑯ Temperature probe, „Consumer“
- ⑰ Temperature probe, „Return“

ITH

Heat transfer systems with thermal oil in explosion-protected version

Explosion Protection Directive 94/9/EC (ATEX)

Systems for heating and cooling for siting in Ex Zones 1 or 2 with mounted explosion-proof control cabinet.



Heat transfer system ITH 350 Ex



Features

- Pipework diagram with parts list of all components
- Explosion protection certification for complete system and all relevant single parts
- Circuit diagram with parts list of all components
- Bellows seals
- Graphite gaskets
- Easy to service and maintain flange connection
- Technically sealed version
- System and control cabinet as Exd or Exp version
- CE certificate of conformity
- Third-party type-examination certificate

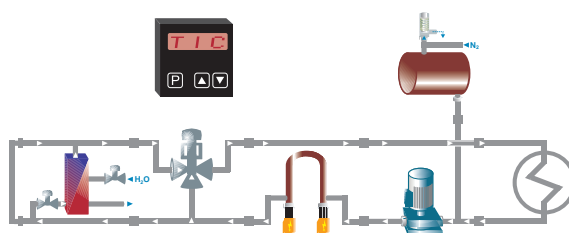

All systems are available with shell and tube heat exchanger



Technical data for standard modules: see pages 10 to 13

Technical features		ITH 150	ITH 250	ITH 350	ITH 400	ITH 600
Heat transfer fluid		Thermal oil				
Working temperature	°C	max. 400				
Pump flow rate	m ³ /h	0.5...2	2...4	4...10	10...30	30...80
Heater power	kW	3...6	9...12	18...50	60...100	120...500
Cooling		Water, brine or air-cooled heat exchanger				
Dimensions (WxDxH) min.	mm	500x800x1000	500x1000x1200	500x1000x1500	600x1500x1500	1000x1500x1900
Dimensions (WxDxH) max.*	mm			600x1500x1500	1000x1500x1900	1300x1900x2000

Technical features		ITH 150 Ex	ITH 250 Ex	ITH 350 Ex	ITH 400 Ex	ITH 600 Ex
Heat transfer fluid		Thermal oil				
Working temperature	°C	max. 400				
Pump flow rate	m ³ /h	0.5...2	2...4	4...10	10...30	30...80
Heater power	kW	3...6	9...12	18...50	60...100	120...500
Cooling		Water, brine or air-cooled heat exchanger				
Dimensions (WxDxH) min.	mm	500x800x1000	500x1000x1800	500x1000x1800	800x1500x1800	1000x1500x1900
Dimensions (WxDxH) max.*	mm			800x1500x1800	1000x1500x1900	1300x1900x2000

* For versions with more powerful modules

LAUDA ITHW Heat transfer systems

The universal systems up to 200 °C



Application examples

- Temperature control of stirrer tanks
- Temperature control of reactors in chemistry, pharmaceuticals and biotechnology
- Environmental simulation, automotive and solar technology
- Use in materials testing, research and production
- Temperature control of heat exchangers and evaporators

Environmentally friendly, versatile, corrosion-free

LAUDA Heating and cooling systems from the line of heat transfer systems in the ITHW model series always consist of the electrical heating module, circulating pump, expansion tank and a maximum of one heat exchanger module (cooler). The systems can be equipped with a water, brine or air-cooled heat exchanger. If a cooling water



network is available, the heat transfer fluid can be directly coupled. The heat exchanger and expansion tank are then omitted. The enclosed versions of the systems produce a temperature controlled liquid flow and are supplied as compact, completely insulated, ready-to-use systems with a control cabinet. They are fully tested at the factory.

Your advantages at a glance

+

The ITHW advantages

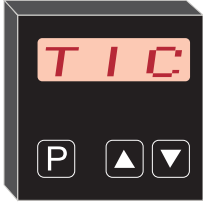
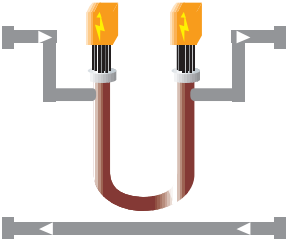
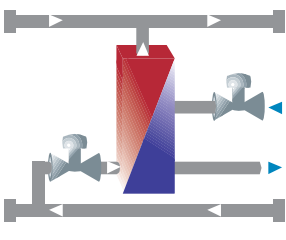
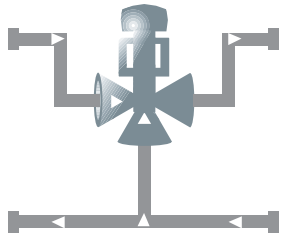
Your benefits

	<ul style="list-style-type: none"> • Digital temperature controller 	<ul style="list-style-type: none"> • Control of the outflow temperature or the consumer/product temperature • Temperature program /ramp mode • External setpoint adjustment via Profibus, Modbus or other interfaces • Preselection of heating and cooling times • Control accuracy $\pm 0.1\text{ }^{\circ}\text{C}$
	<ul style="list-style-type: none"> • Continuously controlled stainless steel electric heater as a flange version 	<ul style="list-style-type: none"> • Fast replacement during servicing • Heating power is adapted to actual energy requirement • Long heater service life due to flow design • Low pressure loss
	<ul style="list-style-type: none"> • Water, brine or air-cooled plate heat exchanger in stainless steel or shell and tube heat exchanger in flange version • Hermetic version without seals • Automatic shut-off valve on cooling water inlet • Return temperature limit on cooling water 	<ul style="list-style-type: none"> • Easy heat exchanger replacement • No mixing with other media • Contamination of heat exchanger avoided • Corrosion and calcification avoided
	<ul style="list-style-type: none"> • Three-way control valve with actuator in flange version • Stepless temperature control • Limitation of the cooling mediums' return temperatures 	<ul style="list-style-type: none"> • Stabilization of minimal cooling powers • Due to bypass operation, no steam hammering in heat exchanger • Gentle cooling • No thermostatic changeover in the heat exchanger on switching from cooling to heating
	<ul style="list-style-type: none"> • Complete system test in LAUDA Test Bed before shipment; system with CE label • Functional testing of all components and checking of all set values • Pressure/leakage test with the heat transfer fluid • Test of control cabinet and control accuracy • Production of a test protocol; documentation of the tests carried out • FAT (Factory Acceptance Test) in presence of customer 	<ul style="list-style-type: none"> • Hot and cold runs with the heat carrier at maximum and minimum operating temperatures • Systems quickly ready for operation, short commissioning times • Avoidance or prevention of leakage • Verification of control accuracy and high-precision processes • Check of all performance verifications • Systems designed to customer requirements, initial instruction and trial run already before shipment

ITHW Heat transfer systems with water

Electrically heated temperature control systems with water as heat transfer fluid are preferably used when a consumer is to be heated or temperature controlled at medium operating temperatures and high heat transfer values. These systems are simple and quick to install and need only a slight amount of maintenance. Equipped with a cooler, a ready-to-use heating and cooling system is produced.

Water is the ideal heat transfer fluid in the medium temperature range. Water is economical, non-toxic, non-combustible and has very high thermal transfer values. This means that the areas for thermal transfer can be kept small. However, the risk of freezing, corrosion and the high vapor pressure (already 15 bar at 200 °C) must be considered during project engineering. Often additives such as glycol are used which also acts as a corrosion protection agent.



Heat transfer system ITHW 150

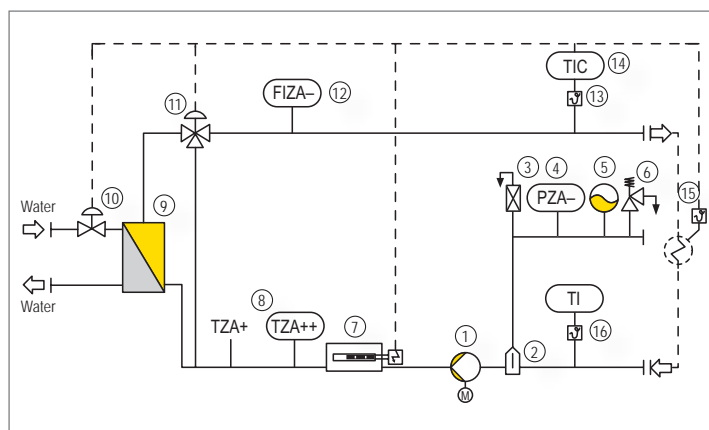

Standards and guidelines considered

- EN 12828 (Heating systems in buildings - Design of water-based heating systems)
- PED 97/23/EC (Pressure Equipment Directive)
- 2006/42/EC (Machinery Directive)
- 2006/95/EC (Low Voltage Directive)
- 2004/108/EC (EMC Directive)
- AD 2000 (Technical regulations for pressurized vessels and pipes)
- 94/9/EC (Guide on explosion protection for machinery - ATEX)

Through modular design

- Expandable
- Modifiable
- Combinable
- Safety equipment with tested components
- Calibrated temperature probe
- Calibrated PID temperature controller with programmer and display for ramp mode
- Control cabinet on the units or mounted separately
- Internal or external expansion tank

- ① Circulating pump
- ② Air/gas separator
- ③ Automatic venting valve
- ④ Pressure monitoring
- ⑤ Expansion tank
- ⑥ Safety valve
- ⑦ Electric heater
- ⑧ Temperature monitoring
- ⑨ Heat exchanger, „Cooling“
- ⑩ Valve, „Cooling“
- ⑪ Three-way valve
- ⑫ Flow monitoring
- ⑬ Temperature probe, „Outflow“
- ⑭ Temperature controller
- ⑮ Temperature probe, „Consumer“
- ⑯ Temperature probe, „Return“

ITHW

Heat transfer systems with water in explosion-protected version

Explosion Protection Directive 94/9/EC (ATEX)

Units for heating and cooling for siting in Ex Zones 1 or 2 with mounted explosion-proof control cabinet. Systems also available in stainless steel version.



Heat transfer system ITHW 400 Ex



Features

- Pipework diagram with parts list of all components
- Explosion protection certification for complete system and all relevant single parts
- Circuit diagram with parts list of all components
- Graphite gaskets
- Easy to service and maintain flange connection
- Technically sealed version
- System and control cabinet as Exd or Exp version
- CE certificate of conformity
- Third-party type-examination certificate

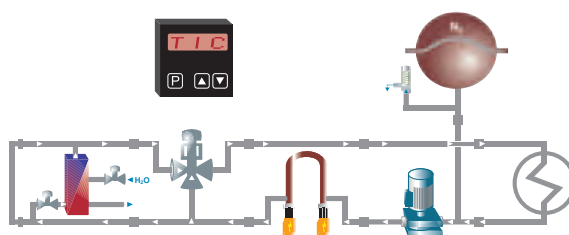

All systems are available with shell and tube heat exchanger



Technical data for standard modules: see pages 10 to 13

Technical features		ITHW 150	ITHW 250	ITHW 350	ITHW 400	ITHW 600
Heat transfer fluid		Water, water/glycol				
Working temperature	°C	max. 200				
Pump flow rate	m ³ /h	0.5...2	2...4	4...10	10...30	30...80
Heater power	kW	6...12	18...24	30...50	60...100	120...500
Cooler		Water, brine or air-cooled heat exchanger				
Dimensions (WxDxH) min.	mm	400x800x1000	500x1000x1500	500x1000x1500	600x1500x1500	1000x1500x1900
Dimensions (WxDxH) max.*	mm			600x1500x1500	1000x1500x1900	1300x1900x2000

Technical features		ITH 150W Ex	ITH 250W Ex	ITH 350W Ex	ITH 400W Ex	ITH 600W Ex
Heat transfer fluid		Water, water/glycol				
Working temperature	°C	max. 200				
Pump flow rate	m ³ /h	0.5...2	2...4	4...10	10...30	30...80
Heater power	kW	6...12	18...24	30...50	60...100	120...500
Cooler		Water, brine or air-cooled heat exchanger				
Dimensions (WxDxH) min.	mm	400x800x1000	500x1000x1500	500x1000x1500	600x1500x1500	1000x1500x1900
Dimensions (WxDxH) max.*	mm			600x1500x1500	1000x1500x1900	1300x1900x2000

* For versions with more powerful modules

Application example

LAUDA Heat transfer systems built into test benches



Application example

- Test benches for the testing and certification of solar thermal collectors

Several projects have already been realized for the field of solar technology in the last ten years. At LAUDA the systems and control technology have been further developed and optimized, particularly for the validation of solar collectors.

The illustration shows a system which is sited in an air-conditioned container (heating or cooling, depending on the season and on the demand) situated in a sunny ambient with raised am-

ambient temperature. A highly precision tracking system keeps the collectors following the sun, best incidence. The heat transfer system is operated in a working temperature range from 5 up to 120 °C. The control accuracy is ± 0.05 K.

Through the container design the system also withstands the extreme UV radiation. Heating and cooling is realized by the LAUDA system.

Requirements for test benches

The requirements on today's test benches or the testing and development of thermal solar collectors are increasing all the time. So institutes and manufacturers are examining additional factors affecting the collectors and collector systems – also beyond the scope of the relevant standards. This results in demands for shorter development and test phases and comprehensive data acquisition and documentation of the data.

During the power measurement on concentrating collectors, in particular, the angle of incidence of the sun plays a significant role. In order to be able to precisely calculate such systems exact tracking of the test object is necessary with respect to the solar position. To cater for the most varied demands on the measurement of all collector designs, the illustrated outdoor test bench shown at the left side was developed for performance measurement. LAUDA produced and delivered the heating and cooling system for this application.



Heat transfer system in the container

Example of a solar test system for performance measurement, worked out with the LAUDA module configurator.

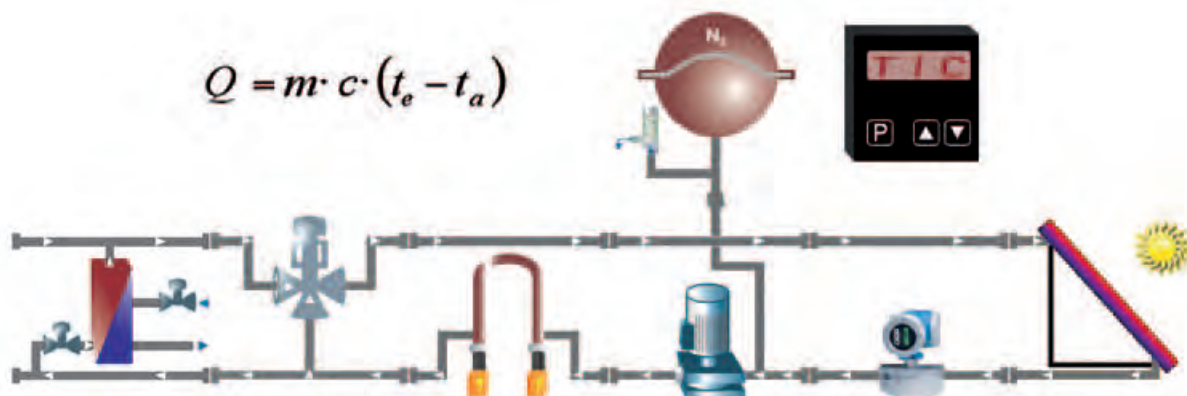

The quantity of heat Q which must be supplied for heating a certain substance depends on the amount of the substance (m), the difference between the initial (t_a) and the final temperatures (t_e) and the specific heat of the

substance (c). It is defined by the equation above. The mass flow and temperature on the collector outlet are variable and are controlled by LAUDA.



Weatherproof protection

The LAUDA Heating and cooling systems in the container are weatherproof. Depending on the siting location the equipment the space inside the container can be heated or cooled.

Of course, the containers are well lit and equipped with an electrical socket for service and maintenance.

LAUDA SUK

Process cooling systems

The cooling systems from -100 up to 150 °C



Application examples

- Temperature control of stirrer tanks
- Temperature control of reactors in chemistry, pharmaceuticals and biotechnology
- Environmental simulation, automotive and solar technology
- Use in materials testing, research and production
- Temperature control of heat exchangers and evaporators

Precise, robust, energy-saving

LAUDA Heating and cooling systems from the line of process cooling systems in the SUK model series always consist of the compressor, pump, expansion tank, evaporator and condenser modules. Depending on the lowest operating temperature, single-stage (down to -35 °C) or two-stage compressors (down to -50 °C) are used and with very low temperatures two cooling circuits are used in cascade (down to -100 °C). The condenser can be cooled by water or air. The output is continuously and precisely controlled by the

injection controller. If multiple compressors are present, stage switching saves energy and ensures low-wear partial load operation (automatic compressor system). With an electric heater or a steam heat exchanger the SUK model series can be expanded for temperatures from -100 up to 150 °C. Also precooling using in-house brine or air can be easily realized using the building kit. The application itself dictates whether a cold storage buffer tank is advantageous or not.

Your advantages at a glance



The SUK advantages

Your benefits

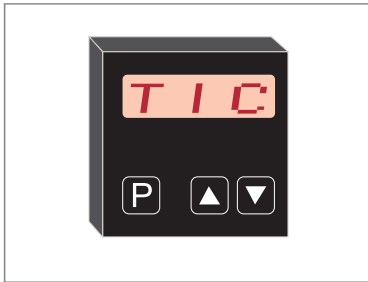

- Digital temperature controller

- Control of the outflow temperature or the consumer/product temperature
- Temperature program/ramp mode
- External setpoint adjustment via Profibus, Modbus or other interfaces
- Preselection of heating and cooling times
- Control accuracy $\pm 0.1\text{ }^{\circ}\text{C}$

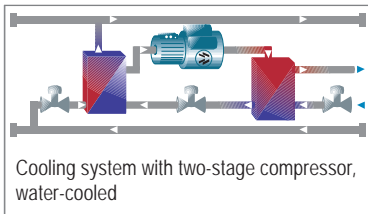

- Cooling module for best possible configuration of compressor and performance quantity
- Single-stage, two-stage and cascade modules available

- Highly dynamic, energy-efficient cooling system
- Optimized method to suit desired operating temperature range

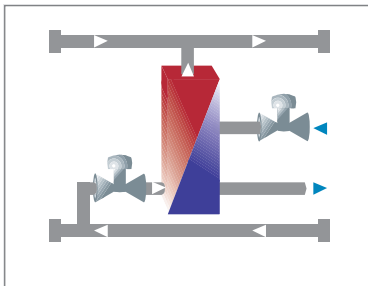

- Stainless steel, water or air-cooled condenser in flange version
- Hermetic version without seals
- Automatic shut-off valve on cooling water inlet
- Cooling water control valve in cooling water inlet
- Return temperature limit on cooling water

- Easy cleaning of the heat exchanger
- Oils and water are not mixed
- Contamination of heat exchanger reduced
- Efficient cooling of the coolant
- Corrosion and calcification avoided

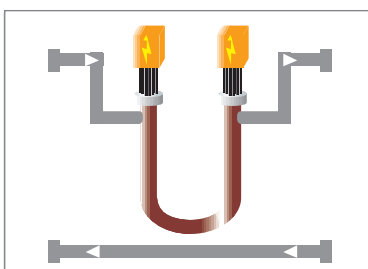

- Continuously controlled stainless steel electric heater as a flange version
- Steam for heating

- Heating power is adapted to actual energy requirement
- For extending temperature range upwards
- No start-up peaks
- Low running costs



- Complete system test in LAUDA Test Bed before shipment; system with CE label
- Functional testing of all components and checking of all set values
- Pressure/leakage test with the heat transfer fluid
- Test of control cabinet and control accuracy
- Production of a test protocol; documentation of the tests carried out
- FAT (Factory Acceptance Test) in presence of customer

- Hot and cold runs with the heat carrier at maximum and minimum operating temperatures
- Systems quickly ready for operation, short commissioning times
- Avoidance or prevention of leakage
- Verification of control accuracy and high-precision processes
- Check of all performance verifications
- Systems designed to customer requirements, initial instruction and trial run already before shipment

SUK Water or air-cooled process cooling systems

Process cooling systems are systems with a compression cooling system, i.e. chilling is produced by means of electrical drive energy using a compression refrigeration process. Depending on the operating temperature range the cooling systems can be operated with the most varied heat transfer fluids.

If heating is also needed, the high pressure with aqueous heat transfer fluids must be considered. In the high temperature range thermal oils are better suited.



Process cooling system SUK 350 W

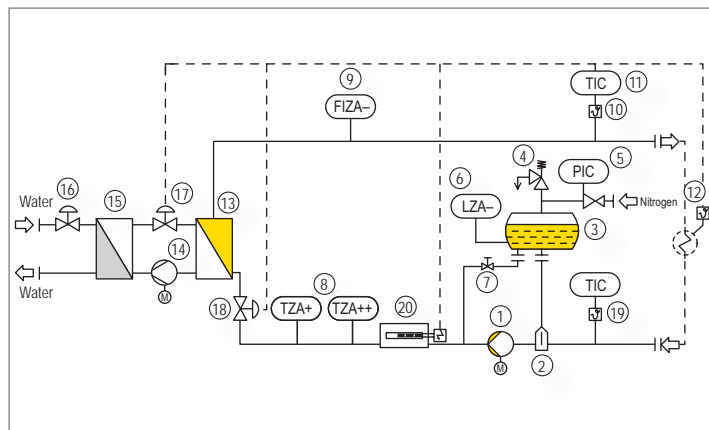

Standards and guidelines considered

- EN 378-1 to 4 (Refrigeration systems and heat pumps)
- PED 97/23/EC (Pressure Equipment Directive)
- AD 2000 (Technical regulations for pressurized vessels and pipes)
- 2006/42/EC (Machinery Directive)
- 2006/95/EC (Low Voltage Directive)
- 2004/108/EC (EMC Directive)
- DIN EN 60204 (Safety of machinery - Electrical equipment of machines)

Through modular design

- Expandable
- Modifiable
- Combinable
- Safety equipment with tested components
- Calibrated temperature probe
- Calibrated PID temperature controller with programmer and display for ramp mode
- Control cabinet on the units or mounted separately
- Internal or external expansion tank

- ① Circulating pump
- ② Air/gas separator
- ③ Expansion tank
- ④ Safety valve
- ⑤ Pressure controller
- ⑥ Level monitoring
- ⑦ Boil-out valve
- ⑧ Temperature monitoring
- ⑨ Flow monitoring
- ⑩ Temperature probe, „Outflow“
- ⑪ Temperature controller
- ⑫ Temperature probe, „Consumer“
- ⑬ Evaporator
- ⑭ Compressor
- ⑮ Condenser
- ⑯ Valve, „Cooling“
- ⑰ Control valve, „Cooling“
- ⑱ Valve, „Cooling“
- ⑲ Temperature probe, „Return“
- ⑳ Electric heater

SUK

Water or air-cooled process cooling systems in explosion-protected version

Explosion Protection Directive 94/9/EC (ATEX)

Systems for cooling and heating for siting in Ex Zones 1 or 2 with mounted explosion-proof control cabinet or control cabinet for separate siting.



Process cooling system
SUK 150 L Ex



Features

- Pipework diagram with parts list of all components
- Explosion protection certification for complete system and all relevant single parts
- Circuit diagram with parts list of all components
- Bellow seals
- Graphite gaskets
- Easy to service and maintain flange connection
- Technically sealed version
- System and control cabinet as Exd or Exp version
- CE certificate of conformity
- Third-party type-examination certificate

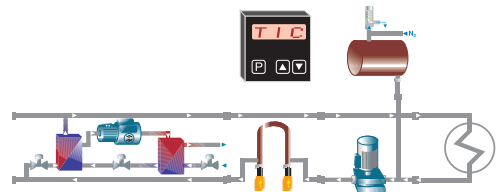

All systems are available with air-cooled condenser



Technical data for standard modules: see pages 10 to 13
All systems can also be supplied with explosion protection

Technical features		SUK 150 W/L(Ex)	SUK 250 W/L(Ex)	SUK 350 W/L(Ex)	SUK 400 W/L(Ex)	SUK 600 W/L(Ex)	SUK 1000 W/L(Ex)
Heat transfer fluid		Water, water/glycol, thermal oil, special liquids					
Working temperature	°C	-40...150	-50...150	-70...150	-100...150	-100...150	-100...150
Pump flow rate	m³/h	0.5...2	2...6	2...20	4...30	5...50	10...80
Heater power	kW	up to 9	up to 18	up to 50	up to 60	up to 120	up to 240
Single-stage compressor							
Cooling output at 20 °C	kW	up to 10	up to 20	up to 50	up to 150	up to 300	up to 400
Cooling output at 0 °C	kW	up to 5	up to 15	up to 35	up to 120	up to 240	up to 300
Cooling output at -20 °C	kW	up to 3	up to 6	up to 18	up to 60	up to 120	up to 180
Cooling output at -40 °C	kW	up to 1	up to 2	up to 7	up to 45	up to 90	up to 120
Two-stage compressor							
Cooling output at -50 °C	kW		up to 1	up to 4	up to 35	up to 70	up to 90
Two-stage cascade							
Cooling output at -60 °C	kW			up to 3	up to 25	up to 50	up to 70
Cooling output at -70 °C	kW			up to 2	up to 10	up to 20	up to 35
Cooling output at -80 °C	kW			up to 0,5	up to 5	up to 10	up to 20
Dimensions (WxDxH) min.	mm	400x800x1000	500x1000x1500	800x1700x1500	1000x1500x1900	1500x2200x2000	1500x2200x2000
Dimensions (WxDxH) max.*	mm	500x1000x1500	600x1500x1500	1000x1500x1900	1300x1900x2000	2000x2500x2000	2000x2500x2000

* For versions with more powerful modules

LAUDA DV

Process cooling systems

The cooling systems from -110 up to 20 °C



Application examples

- Solvent recondensation
- Direct evaporator for air cleaning contaminated gas
- Vacuum coating system

Recondensation, direct evaporation, air drying

LAUDA heating and cooling systems from the line of process cooling systems in the DV model series always consist of the compressor, evaporator and condenser modules. Depending on the lowest operating temperature, single-stage (down to -35 °C) or two-stage compressors (down to -50 °C) are used and with very low temperatures

two cooling circuits are used in cascade (down to -100 °C). The condenser can be cooled by water or air. The output is continuously and precisely controlled by the injection controller. If multiple compressors are present, stage switching saves energy and ensures low-wear partial load operation (automatic compressor system).

Your advantages at a glance

+

The DV advantages

Your benefits

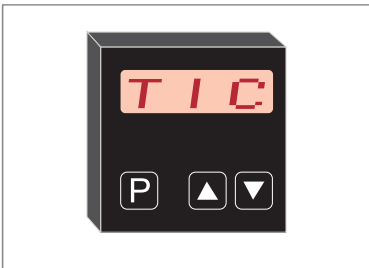

- Digital temperature controller

- Control of the outflow temperature or the consumer/product temperature
- Temperature program/ramp mode
- External setpoint adjustment via Profibus, Modbus or other interfaces
- Preselection of heating and cooling times
- Control accuracy $\pm 0.1\text{ }^{\circ}\text{C}$

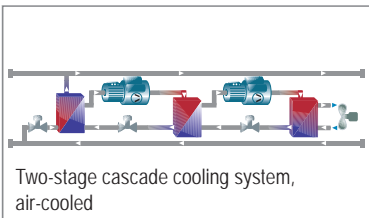

- Cooling module for best possible configuration of compressor and performance quantity
- Single-stage, two-stage and cascade modules

- Highly dynamic, energy-efficient cooling system
- Suitable for desired operating temperature range

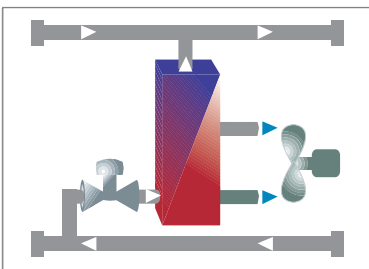

- Air-cooled condenser
- Split version for outdoor siting of air-cooled condenser

- Improved operating costs, saves water
- Cooling with respect to outside air
- Low-noise operation
- Siting space in building is saved



- Complete system test in LAUDA Test Bed before shipment; system with CE label
- Functional testing of all components and checking of all set values
- Pressure/leakage test with the heat transfer fluid
- Test of control cabinet and control accuracy
- Production of a test protocol; documentation of the tests carried out
- FAT (Factory Acceptance Test) in presence of customer

- Hot and cold runs with the heat carrier at maximum and minimum operating temperatures
- Systems quickly ready for operation, short commissioning times
- Avoidance or prevention of leakage
- Verification of control accuracy and high-precision processes
- Check of all performance verifications
- Systems designed to customer requirements, initial instruction and trial run already before shipment

LAUDA DV

DV Water or air-cooled process cooling systems

Process cooling systems in the DV model series are systems with a compression cooling system, i.e. chilling is produced by means of electrical drive energy using a compression refrigeration process. Depending on the operating temperature range the cooling systems can be operated as direct evaporator with the most varied refrigerants and with existing external pump with varied heat transfer fluids.



Process cooling system DV 400 W



Standards and guidelines considered

- EN 378-1 to 4 (Refrigeration systems and heat pumps)
- PED 97/23/EC (Pressure Equipment Directive)
- AD 2000 (Technical regulations for pressurized vessels and pipes)
- 2006/42/EC (Machinery Directive)
- 2006/95/EC (Low Voltage Directive)
- 2004/108/EC (EMC Directive)
- DIN EN 60204 (Safety of machinery - Electrical equipment of machines)

Through modular design

- Expandable
- Modifiable
- Combinable
- Safety equipment with tested components
- Calibrated temperature probe
- Calibrated PID temperature controller with programmer and display for ramp mode
- Control cabinet on the units or mounted separately
- External expansion tank and pumps

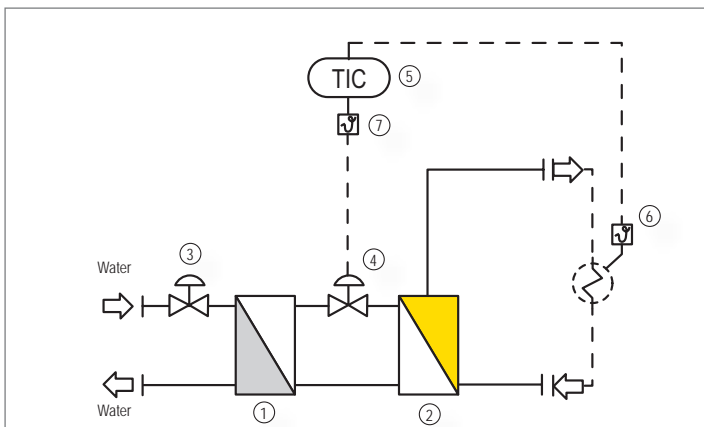

- ① Condenser
- ② Evaporator
- ③ Valve, „Cooling“
- ④ Control valve, „Cooling“
- ⑤ Temperature controller
- ⑥ Temperature probe, „Consumer“
- ⑦ Temperature probe, „Outflow“

DV Water or air-cooled process cooling systems in explosion-protected version

Explosion Protection Directive 94/9/EC (ATEX)

Systems for cooling and heating for siting in Ex Zones 1 or 2 with mounted explosion-proof control cabinet or control cabinet for separate siting.



Process cooling system DV 400 W Ex



Features

- Pipework diagram with parts list of all components
- Explosion protection certification for complete system and all relevant single parts
- Circuit diagram with parts list of all components
- Bellow seals
- Graphite gaskets
- Easy to service and maintain flange connection
- Technically sealed version
- System and control cabinet as Exd or Exp version
- CE certificate of conformity
- Third-party type-examination certificate

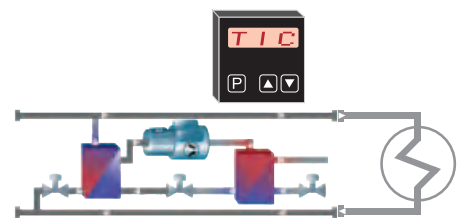

All systems are available with air-cooled condenser



Technical data for standard modules: see pages 10 to 13
All systems can also be supplied with explosion protection

Technical features		DV 150 W/L(Ex)	DV 250 W/L(Ex)	DV 350 W/L(Ex)	DV 400 W/L(Ex)	DV 600 W/L(Ex)	DV 1000 W/L(Ex)
Heat transfer fluid (external pump)		Water, water/glycol, thermal oil, special liquids					
Working temperature	°C	-40...20	-50...20	-70...20	-100...20	-100...20	-100...20
Single-stage compressor							
Cooling output at 20 °C	kW	up to 10	up to 20	up to 50	up to 150	up to 300	up to 400
Cooling output at 0 °C	kW	up to 5	up to 15	up to 35	up to 120	up to 240	up to 300
Cooling output at -20 °C	kW	up to 3	up to 6	up to 18	up to 60	up to 120	up to 180
Cooling output at -40 °C	kW	up to 1	up to 2	up to 7	up to 45	up to 90	up to 120
Two-stage compressor							
Cooling output at -50 °C	kW		up to 1	up to 4	up to 35	up to 70	up to 90
Two-stage cascade							
Cooling output at -60 °C	kW			up to 3	up to 25	up to 50	up to 70
Cooling output at -70 °C	kW			up to 2	up to 10	up to 20	up to 35
Cooling output at -80 °C	kW			up to 0,5	up to 5	up to 10	up to 20
Dimensions (WxDxH) min.	mm	400x800x1000	500x1000x1500	800x1700x1500	1000x1500x1900	1500x2200x2000	1500x2200x2000
Dimensions (WxDxH) max.*	mm	500x1000x1500	600x1500x1500	1000x1500x1900	1300x1900x2000	2000x2500x2000	2000x2500x2000

* For versions with more powerful modules

LAUDA KH Process cooling systems

The cooling systems from -100 up to 400 °C



Application examples

- Temperature control of stirrer tanks
- Temperature control of reactors in chemistry, pharmacy and biotechnology
- Environmental simulation, automotive and solar technology
- Use in materials testing, research and production
- Temperature control of heat exchangers and evaporators



Highly dynamic systems, the latest technology

LAUDA Heating and cooling systems from the line of process cooling systems in the KH (Kryoheater) model series always consist of the compressor, pump, expansion tank, heater, three-way valve, evaporator and condenser modules. Depending on the lowest operating temperature, single-stage (down to -35 °C) or two-stage compressors (down to -50 °C) are used and with very low temperatures two cooling circuits are used in cascade (down to -100 °C). The condenser can be cooled by water or air. The output is continuously and precisely

controlled by the injection controller. If multiple compressors are present, stage switching saves energy and ensures low-wear partial load operation (automatic compressor system). Due to the electric heater and/or heat exchangers heated by media, the Kryoheater model series can cover the operating temperature range from -100 up to 400 °C. Also precooling using in-house brine or air can be easily realized thanks to the modular construction. The application itself dictates whether a cold storage buffer tank is advantageous or not.

Your advantages at a glance

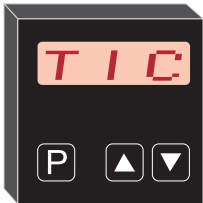
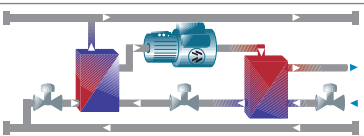
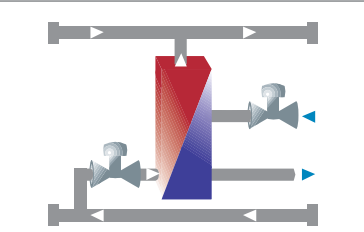
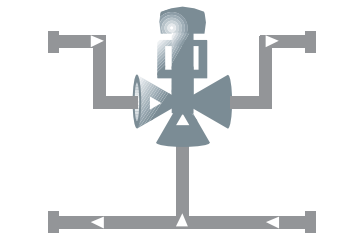
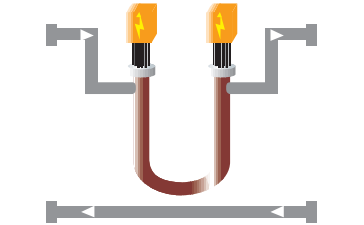
+ The KH advantages Your benefits

	<ul style="list-style-type: none"> • Digital temperature controller 	<ul style="list-style-type: none"> • Control of the outflow temperature or the consumer/product temperature • Temperature program/ramp mode • External setpoint adjustment via Profibus, Modbus or other interfaces • Preselection of heating and cooling times • Control accuracy $\pm 0.1\text{ }^{\circ}\text{C}$
 <p>Cooling system with two-stage compressor, water-cooled</p>	<ul style="list-style-type: none"> • Cooling module for best possible configuration of compressor and performance quantity • Single-stage, two-stage and cascade modules available 	<ul style="list-style-type: none"> • Highly dynamic, energy-efficient cooling system • Suitable for desired operating temperature range
	<ul style="list-style-type: none"> • Stainless steel, water or air-cooled condenser in flange version • Hermetic version without seals • Automatic shut-off valve on cooling water inlet • Cooling water control valve in cooling water inlet • Return temperature limit on cooling water 	<ul style="list-style-type: none"> • Easy cleaning of the heat exchanger • Oils and water are not mixed • Contamination of heat exchanger reduced • Efficient cooling of the coolant • Corrosion and calcification avoided
	<ul style="list-style-type: none"> • Three-way control valve with bellows and actuator in flange version 	<ul style="list-style-type: none"> • Separation of heating and cooling circuits for extreme operating temperature ranges • Stabilization of minimal cooling powers • Gentle cooling – gentle heating • No thermal stress on switching from cooling to heating • Long service life of the heating and cooling system
	<ul style="list-style-type: none"> • Continuously controlled stainless steel electric heater as a flange version • Steam for heating 	<ul style="list-style-type: none"> • Heating power is adapted to actual energy requirement • For extending temperature range upwards • No start-up peaks • Low running costs
	<ul style="list-style-type: none"> • Complete system test in LAUDA Test Bed before shipment; system with CE label • Functional testing of all components and checking of all set values • Pressure/leakage test with the heat transfer fluid • Test of control cabinet and control accuracy • Production of a test protocol; documentation of the tests carried out • FAT (Factory Acceptance Test) in presence of customer 	<ul style="list-style-type: none"> • Hot and cold runs with the heat carrier at maximum and minimum operating temperatures • Systems quickly ready for operation, short commissioning times • Avoidance or prevention of leakage • Verification of control accuracy and high-precision processes • Check of all performance verifications • Systems designed to customer requirements, initial instruction and trial run already before shipment

KH Water or air-cooled process cooling systems

Continually changing methods in the manufacture of the most varied products demand an ever increasing scope of temperatures. Intensely exothermic batch processes can only be controlled with highly dynamic thermostatic systems, such as the heating and cooling systems from LAUDA. The Kryoheaters fulfill the high requirements of thermostatic systems and already offer the modern heat transfer technology. The technology of Kryoheaters covers a range from -100 up to 400 °C. The field of application is currently only restricted by the physical properties of the available heat transfer fluids.



Process cooling system Kryoheater KH 400 W

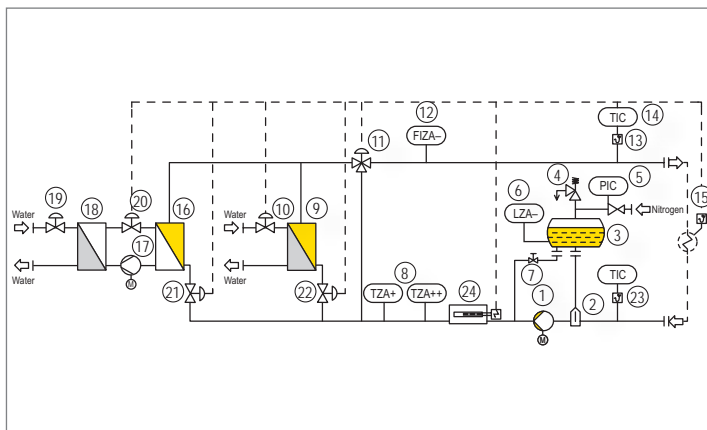

Standards and guidelines considered

- EN 378-1 to 4 (Refrigeration systems and heat pumps)
- PED 97/23/EC (Pressure Equipment Directive)
- AD 2000 (Technical regulations for pressurized vessels and pipes)
- 2006/42/EC (Machinery Directive)
- 2006/95/EC (Low Voltage Directive)
- 2004/108/EC (EMC Directive)
- DIN EN 60204 (Safety of machinery - Electrical equipment of machines)
- DIN 4754 (Heat transfer installations working with organic heat transfer fluids)

Through modular design

- Expandable
- Modifiable
- Combinable
- Safety equipment with tested components
- Calibrated temperature probe
- Calibrated PID temperature controller with programmer and display for ramp mode
- Control cabinet on the units or mounted separately
- Internal or external expansion tank

- ① Circulating pump
- ② Air/gas separator
- ③ Expansion tank
- ④ Safety valve
- ⑤ Pressure controller
- ⑥ Level monitoring
- ⑦ Boil-out valve
- ⑧ Temperature monitoring
- ⑨ Heat exchanger, „Cooling“
- ⑩ Valve, „Cooling“
- ⑪ Three-way valve
- ⑫ Flow monitoring
- ⑬ Temperature probe, „Outflow“
- ⑭ Temperature controller
- ⑮ Temperature probe, „Consumer“
- ⑯ Evaporator
- ⑰ Compressor
- ⑱ Condenser
- ⑲ Valve, „Cooling“
- ⑳ Control valve, „Chilling“
- ㉑ Valve, „Chilling“
- ㉒ Valve, „Cooling“
- ㉓ Temperature probe, „Return“
- ㉔ Electric heater

KH

Water or air-cooled process cooling systems in explosion-protected version

Explosion Protection Directive 94/9/EC (ATEX)

Systems for cooling and heating for siting in Ex Zones 1 or 2 with mounted explosion-proof control cabinet or control cabinet for separate siting.



Process cooling system Kryoheater KH 250 W Ex



Features

- Pipework diagram with parts list of all components
- Explosion protection certification for complete system and all relevant single parts
- Circuit diagram with parts list of all components
- Bellow seals
- Graphite gaskets
- Easy to service and maintain flange connection
- Technically sealed version
- System and control cabinet as Exd or Exp version
- CE certificate of conformity
- Third-party type-examination certificate

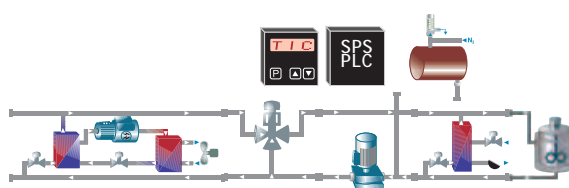

All systems are available with air-cooled condenser



Technical data for standard modules: see pages 10 to 13
All systems can also be supplied with explosion protection

Technical features		KH 150 W/L(Ex)	KH 250 W/L(Ex)	KH 350 W/L(Ex)	KH 400 W/L(Ex)	KH 600 W/L(Ex)	KH 1000 W/L(Ex)
Heat transfer fluid		Thermal oil, special liquids					
Working temperature	°C	-40...250	-50...250	-70...250	-100...250	-100...250	-100...400
Pump flow rate	m³/h	0.5...2	2...6	2...20	4...30	5...50	10...80
Heater power	kW	up to 9	up to 18	up to 50	up to 60	up to 120	up to 240
Single-stage compressor							
Cooling output at 20 °C	kW	up to 10	up to 20	up to 50	up to 150	up to 300	up to 400
Cooling output at 0 °C	kW	up to 5	up to 15	up to 35	up to 120	up to 240	up to 300
Cooling output at -20 °C	kW	up to 3	up to 6	up to 18	up to 60	up to 120	up to 180
Cooling output at -40 °C	kW	up to 1	up to 2	up to 7	up to 45	up to 90	up to 120
Two-stage compressor							
Cooling output at -50 °C	kW		up to 1	up to 4	up to 35	up to 70	up to 90
Two-stage cascade							
Cooling output at -60 °C	kW			up to 3	up to 25	up to 50	up to 70
Cooling output at -70 °C	kW			up to 2	up to 10	up to 20	up to 35
Cooling output at -80 °C	kW			up to 0,5	up to 5	up to 10	up to 20
Dimensions (WxDxH) min.	mm	500x1000x1500	600x1500x1500	800x1700x1500	1000x1500x1900	1500x2200x2000	1500x2200x2000
Dimensions (WxDxH) max.*	mm	600x1500x1500	800x1700x1500	1000x1500x1900	1300x1900x2000	2000x2500x2000	2000x2500x2000

* For versions with more powerful modules

Application example

LAUDA process cooling system in combination with a freeze dryer

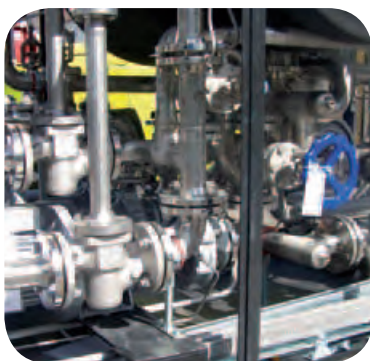

Whereas foodstuffs represent the most important application of freeze drying with regard to quantity, biotechnological and pharmaceutical products, e.g. vaccines, require devices and systems satisfying the highest quality standards. Freeze drying is an important process which in pharmaceuticals makes high demands on the heating and cooling system. Freeze drying is used for more than thirty different categories of substances or materials, whereby the application in the pharmaceutical sector and in biotechnology as well as for improving the durability of foodstuffs are the most significant markets.

extremely low temperature. The vapor must be continuously extracted, otherwise an equilibrium sets in and the evaporation process ceases. To achieve this, powerful cooling takes place at another point; in the ice condensers the cooling system ensures a cryogenic temperature which may lie at $-70\text{ }^{\circ}\text{C}$. The vapor precipitates as ice and the solvent is basically frozen out.

The thermostatic control of freeze drying processes is complex and demanding. Since heavy vacuum chambers are involved, a large amount of cooling energy is required even with cooling before evacuation starts. Ice condensers are often realized with direct evaporators (DV) or also indirectly with two-stage cascades (SUK) and/or in combination with a liquid nitrogen heat exchanger (KP). LAUDA offers the suitable configuration for the relevant process conditions.

To dry products in pharmaceutical applications at a constant $-60\text{ }^{\circ}\text{C}$, heating must in fact be provided. It is only in this way that the required energy of evaporation can be supplied to the liquid in the product. The process runs under vacuum conditions so that the solvent evaporates at an



Application example

- Temperature control during freeze drying

On the subject of freeze drying

Freeze drying or lyophilization is the method of drying materials which is most gentle on the product. The physical phenomenon of sublimation implies a direct transition from the solid to the vapor state, thereby bypassing the liquid state of aggregation. The frozen product is thus dried under vacuum without thawing. The technique offers a wide scope for possible applications. In particular temperature-sensitive products must be dried close to the freezing point (melting point).

Since pharmaceutical products or foodstuffs are located directly within the freeze drying chambers, this equipment is subject to strict validation. A sterilization process must occur after each charge. Apart from material compatibility, the surface quality must conform to the most stringent cleanliness requirements. Of course, the temperature control is also one of the important aspects of successful validation.



Process cooling system DV 400 W

Example of a DV process cooling system, worked out with the LAUDA module configurator.

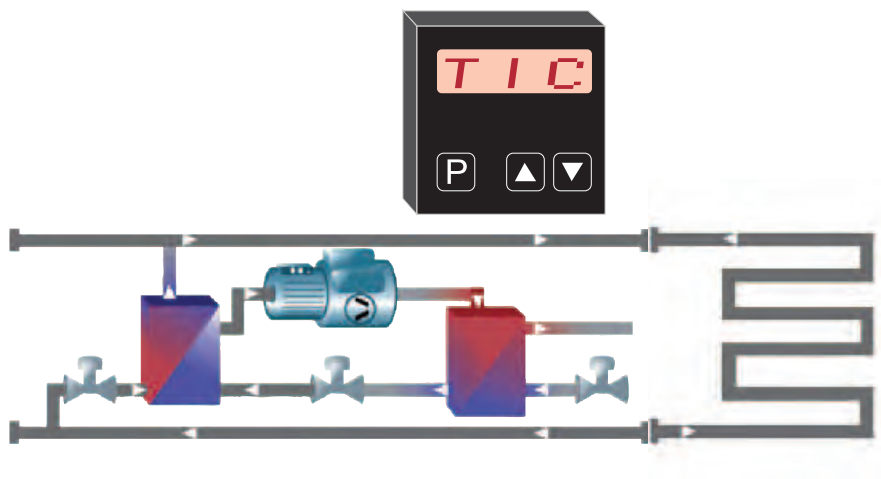

Higher efficiency with a low price of procurement

LAUDA cooling systems of the type DV are the minimum solution for process cooling systems. Through direct evaporation in the actual application section unnecessary energy losses due to a pump and heat transfers are avoided.

Result: High efficiency with a low price of procurement

LAUDA TR Secondary circuit systems

Systems for the use of primary energy from -150 up to 400 °C



Application examples

- Exploitation of existing sorts of primary energy, such as thermal oil, steam, cooling brine and cold oil
- Temperature control of stirrer tanks
- Temperature control of reactors in chemistry, pharmacy and biotechnology
- Use in materials testing, research and production
- Temperature control of heat exchangers and evaporators

Efficient use of primary energy

LAUDA Heating and cooling systems from the line of secondary circuit systems of the TR model series consist either of one or several heat exchanger modules. They have direct media coupling or an electric heater module. The additional letters, such as for example HKT, indicate the

number of heating or cooling modules as well as the thermostatic functions. These systems produce a temperature controlled liquid flow and are designed as a compact, fully insulated system with a control cabinet, ready for connection and completely pretested in the factory.

Your advantages at a glance



The TR advantages

Your benefits



- Digital temperature controller

- Control of the outflow temperature or the consumer/product temperature
- Temperature program/ramp mode
- External setpoint adjustment via Profibus, Modbus or other interfaces
- Preselection of heating and cooling times
- Control accuracy $\pm 0.1\text{ }^{\circ}\text{C}$

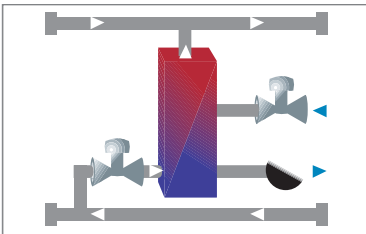

- Heat exchanger in stainless steel or titanium for heating with steam

- Use of steam supplied by customer
- Optimal design for type, material and operating conditions as well as usable heat transfer area
- Transfer of high heating power

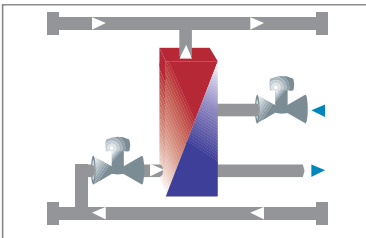

- Heat exchanger in stainless steel or titanium in flange version
- Use of different primary media
- Hermetic version without seals

- Saves on energy costs
- Fast change of temperature control
- Large selection of media
- No mixing with other media

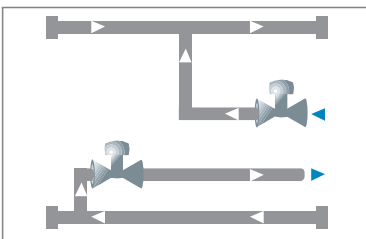

- Direct media coupling

- No power loss when using same medium in the primary system
- No expansion tank needed
- More economically priced



- Complete system test in LAUDA Test Bed before shipment; system with CE label
- Functional testing of all components and checking of all set values
- Pressure/leakage test with the heat transfer fluid
- Test of control cabinet and control accuracy
- Production of a test protocol; documentation of the tests carried out
- FAT (Factory Acceptance Test) in presence of customer

- Hot and cold runs with the heat carrier at maximum and minimum operating temperatures
- Systems quickly ready for operation, short commissioning times
- Avoidance or prevention of leakage
- Verification of control accuracy and high-precision processes
- Check of all performance verifications
- Systems designed to customer requirements, initial instruction and trial run already before shipment

TR Secondary circuit systems

Secondary circuit systems use existing energy sources, such as steam, cooling water and brine – so-called primary systems. Here, the objective is to integrate the existing infrastructure and best possible use of the thermal energy on the primary side. In this way only a single heat transfer fluid circuit is used (single fluid system) on the consumer instead of steam, cooling water and brine circuits. Important advantages arise through the use of only one heat transfer liquid: due to the seamless and reproducible temperature control throughout the whole temperature range changeover to different media is not required. Through the use of thermal oil low operating pressures prevail and the heat carrier also acts as a separating medium between the product and the environment.



Secondary circuit system TR 600 HKT

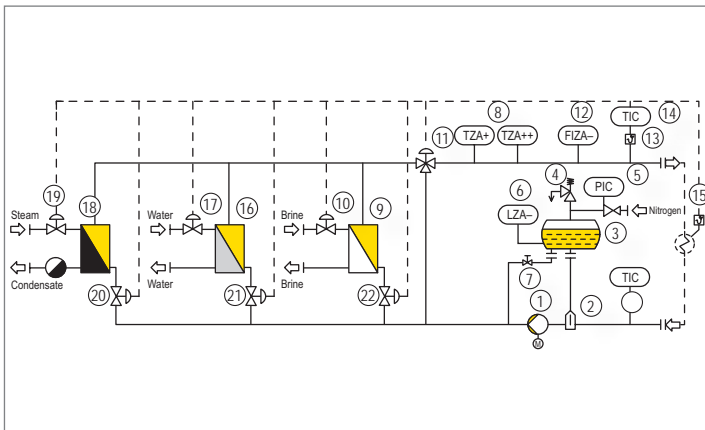

Standards and guidelines considered

- PED 97/23/EG (Pressure Equipment Directive)
- 2006/42/EG (Machinery Directive)
- 2006/95/EG (Low Voltage Directive)
- 2004/108/EG (EMC Directive)
- EN 12828 (Heating systems in buildings - Design of water-based heating systems)
- DIN 4754 (Heat transfer systems working with organic heat transfer fluids)
- AD 2000 (Technical regulations for pressurized vessels and pipes)
- DIN EN 60204 (Safety of machinery - Electrical equipment of machines)

Through modular design

- Expandable
- Modifiable
- Combinable
- Safety equipment with tested components
- Calibrated temperature probe
- Calibrated PID temperature controller with programmer and display for ramp mode
- Control cabinet on the units or mounted separately
- Internal or external expansion tank

- ① Circulating pump
- ② Air/gas separator
- ③ Expansion tank
- ④ Safety valve
- ⑤ Pressure controller
- ⑥ Level monitoring
- ⑦ Boil-out valve
- ⑧ Temperature monitoring
- ⑨ Heat exchanger, „Chilling“
- ⑩ Valve, „Chilling“
- ⑪ Three-way valve
- ⑫ Flow monitoring
- ⑬ Temperature probe, „Outflow“
- ⑭ Temperature controller
- ⑮ Temperature probe, „Consumer“
- ⑯ Heat exchanger, „Cooling“
- ⑰ Valve, „Cooling“
- ⑱ Heat exchanger, „Heating“
- ⑲ Valve, „Heating“
- ⑳ Valve, „Heating“
- ㉑ Valve, „Heating“
- ㉒ Valve, „Chilling“
- ㉓ Temperature probe, „Return“

TR Secondary circuit systems in explosion-protected version

Explosion Protection Directive 94/9/EC (ATEX)

Systems for cooling and heating for siting in Ex Zones 1 or 2 with mounted explosion-proof control cabinet or control cabinet for separate siting.



Secondary circuit system TR 600 HK Ex



Features

- Pipework diagram with parts list of all components
- Explosion protection certification for complete system and all relevant single parts
- Circuit diagram with parts list of all components
- Bellow seals
- Graphite gaskets
- Easy to service and maintain flange connection
- Technically sealed version
- System and control cabinet as Exd or Exp version
- CE certificate of conformity
- Third-party type-examination certificate

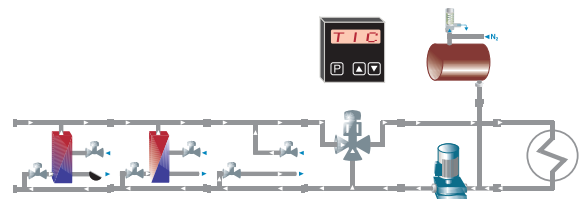

Direct coupling of heat transfer fluids possible



Technical data for standard modules: see pages 10 to 13
All systems can also be supplied with explosion protection

Technical features	TR 150	TR 250	TR 350	TR 400	TR 600
Heat transfer fluid	Water, water/glycol, thermal oil, special liquids				
Working temperature	°C -100...400				
Pump flow rate	m ³ /h 0.5...2	9...12	18...50	60...100	120...180
Thermostatic functions	H (Heating) K (Cooling) T (Chilling) Ts (Ultra-chilling)				
Primary energy	Electrical, steam, hot oil, hot water, air, cooling water, brine, cold oil, nitrogen				
Energy transfer	indirectly via heat exchanger or electric heater, direct coupling				

Technical features	TR 150 (Ex)	TR 250 (Ex)	TR 350 (Ex)	TR 400 (Ex)	TR 600 (Ex)
Heat transfer fluid	Water, water/glycol, thermal oil, special liquids				
Working temperature	°C -100...400				
Pump flow rate	m ³ /h 0.5...2	9...12	18...50	60...100	120...180
Thermostatic functions	H (Heating) K (Cooling) T (Chilling) Ts (Ultra-chilling)				
Primary energy	Electrical, steam, hot oil, hot water, air, cooling water, brine, cold oil, nitrogen				
Energy transfer	indirectly via heat exchanger or electric heater, direct coupling				

LAUDA KP

Secondary circuit systems

The single fluid systems from -150 up to 280 °C



High purity levels for high demands



Application examples

- Low temperature synthesis for high levels of purity
- Employed in materials testing, research and production

LAUDA Heating and cooling systems from the line of secondary circuit systems in the KP (Kryopac) model series always consist of the modules, circulating pump, expansion tank electric heater and the special Kryopac system – a heat exchanger which has been developed for evaporating liquid nitrogen. This system enables low temperature reactions to be safely controlled. The heat technology originates from the well-proven modules of the heat transfer systems. The Kryopac units



and are supplied as a compact, fully insulated system with a control cabinet, ready for connection and completely pretested in the factory. Freezing problems in the heat exchangers are a thing of the past. Commercially available heat carriers can be practically cooled down to the solidification point. The LAUDA technology makes it possible to precisely approach this point. A compact design, high safety standard and favorable price are further advantages of the Kryopac system.

Your advantages at a glance

+

The KP advantages

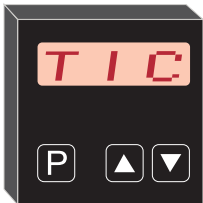
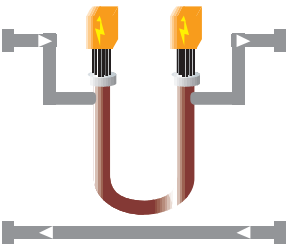
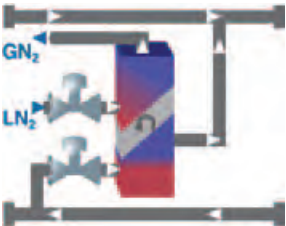
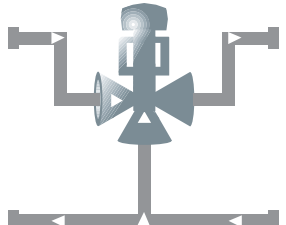
Your benefits

	<ul style="list-style-type: none"> • Digital temperature controller 	<ul style="list-style-type: none"> • Control of the outflow temperature or the consumer/product temperature • Temperature program/ramp mode • External setpoint adjustment via Profibus, Modbus or other interfaces • Preselection of heating and cooling times • Control accuracy $\pm 0.1\text{ }^{\circ}\text{C}$
	<ul style="list-style-type: none"> • Continuously controlled stainless steel electric heater as a flange version 	<ul style="list-style-type: none"> • Low film temperatures • Low surface loading • Long service life of thermal oil • Low pressure loss • Heating power is adapted to actual energy requirement
	<ul style="list-style-type: none"> • Stainless steel Kryopac heat exchanger in flange version • Use of chilling from evaporating nitrogen; transfer to a liquid heat transfer fluid 	<ul style="list-style-type: none"> • Saves on energy costs • Only one heat transfer fluid • No freezing problems with low temperatures in the heat exchangers; the commercially available heat transfer fluid can be cooled down to the solidification point
	<ul style="list-style-type: none"> • Three-way control valve with bellows and actuator in flange version 	<ul style="list-style-type: none"> • Stabilization of the lowest cooling power • Due to bypass operation, no steam hammering in the heat exchanger • Gentle cooling • Efficient heating • No thermostatic changeover in the heat exchanger on switching from cooling to heating
	<ul style="list-style-type: none"> • Complete system test in LAUDA Test Bed before shipment; system with CE label • Functional testing of all components and checking of all set values • Pressure/leakage test with the heat transfer fluid • Test of control cabinet and control accuracy • Production of a test protocol; documentation of the tests carried out • FAT (Factory Acceptance Test) in presence of customer 	<ul style="list-style-type: none"> • Hot and cold runs with the heat carrier at maximum and minimum operating temperatures • Systems quickly ready for operation, short commissioning times • Avoidance or prevention of leakage • Verification of control accuracy and high-precision processes • Check of all performance verifications • Systems designed to customer requirements, initial instruction and trial run already before shipment

KP Secondary circuit systems

In order to achieve still higher levels of purity in modern production methods, reactions are run at very low temperatures. The range of modules from LAUDA includes the Kryopac for this application. Here the cooling power of evaporating nitrogen is exploited and transferred to a liquid heat transfer fluid. Kryopac systems are secondary circuit systems which are cooled with liquid nitrogen on the primary side. For these extreme cooling applications only special low temperature heat transfer fluids are used. LAUDA developed a special technique to solve the known freezing problems. A suitable intermediate medium transfers the cooling of the low temperature nitrogen (-196 °C) to the heat transfer fluid, controlled accurately to the degree.

For this innovative method LAUDA received the European Patent No. 1 030 135.



Secondary circuit system Kryopac KP 600



Standards and guidelines considered

- PED 97/23/EG (Pressure Equipment Directive)
- 2006/42/EG (Machinery Directive)
- 2006/95/EG (Low Voltage Directive)
- 2004/108/EG (EMC Directive)
- DIN 4754 (Heat transfer systems working with organic heat transfer fluids)
- AD 2000 (Technical regulations for pressurized vessels and pipes)
- DIN EN 60204 (Safety of machinery - Electrical equipment of machines)

Through modular design

- Expandable
- Modifiable
- Combinable
- Safety equipment with tested components
- Calibrated temperature probe
- Calibrated PID temperature controller with programmer and display for ramp mode
- Control cabinet on the units or mounted separately
- Internal or external expansion tank

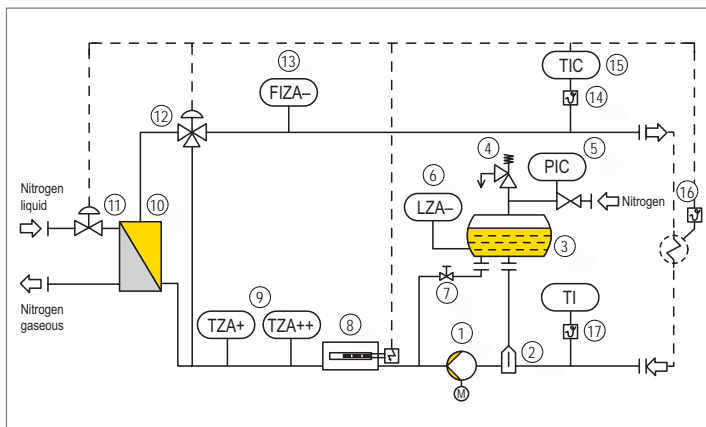

- ① Circulating pump
- ② Air/gas separator
- ③ Expansion tank
- ④ Safety valve
- ⑤ Pressure controller
- ⑥ Level monitoring
- ⑦ Boil-out valve
- ⑧ Electric heater
- ⑨ Temperature monitoring
- ⑩ Heat exchanger „Kryopac“
- ⑪ Valve, „Ultra-chilling“
- ⑫ Three-way valve
- ⑬ Flow monitoring
- ⑭ Temperature probe, „Outflow“
- ⑮ Temperature controllers
- ⑯ Temperature probe, „Consumer“
- ⑰ Temperature probe, „Return“

KP Secondary circuit systems in explosion-protected version

Explosion Protection Directive 94/9/EC (ATEX)

Systems for cooling and heating for siting in Ex Zones 1 or 2 with mounted explosion-proof control cabinet or control cabinet for separate siting.



Secondary circuit system Kryopac KP 350 Ex



Features

- Pipework diagram with parts list of all components
- Explosion protection certification for complete system and all relevant single parts
- Circuit diagram with parts list of all components
- Bellow seals
- Graphite gaskets
- Easy to service and maintain flange connection
- Technically sealed version
- System and control cabinet as Exd or Exp version
- CE certificate of conformity
- Third-party type-examination certificate

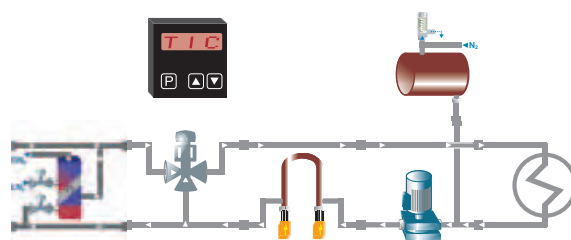

Systems also available for outdoor siting in a container



Technical data for standard modules: see pages 10 to 13
All systems can also be supplied with explosion protection

Technical features		KP 150 (Ex)	KP 250 (Ex)	KP 350 (Ex)	KP 400 (Ex)	KP 600 (Ex)
Heat transfer fluid		Thermal oil, special liquids				
Working temperature	°C	-150...280				
Pump flow rate	m ³ /h	0.5...2	2...4	4...10	10...30	30...80
Heater power	kW	3...6	9...12	18...50	60...100	120...500
Cooling output at -100 °C	kW	up to 5	up to 10	up to 15	up to 30	up to 80
Dimensions (WxDxH) min.	mm	500x1000x1500	600x1500x1500	800x1700x1500	1000x1500x1900	1500x2200x2000
Dimensions (WxDxH) max.*	mm	600x1500x1500	800x1700x1500	1000x1500x1900	1300x1900x2000	2000x2500x2000

* For versions with more powerful modules

Application example

LAUDA secondary circuit systems for low-temperature synthesis



With the simultaneous supply of many items of equipment there is, of course, a substantial energy requirement. Various concepts for generating cooling must be examined and compared with regard to their energy efficiency and costs.

The Kryopac technology uses the cooling of evaporating nitrogen and transfers it via an intermediate medium to a liquid heat carrier. In this way operating temperatures between -100 and 280 °C can be obtained in the single fluid system. The application limits are currently only defined by the heat carriers available on the market.

The illustration above shows a system employed at Allessa-Syntec in the industrial zone at Höchst. The company specializes in the process development and manufacture of complex, high grade chemicals. Many chemical syntheses are only possible at all using low temperatures or they run more selectively when cooled. For example, low-temperature synthesis in the reaction of optically active substances represents a good solution.



Application example

- LAUDA Kryopac low-temperature synthesis for the manufacture of high-grade chemical and pharmaceutical intermediate and end products

High demands on quality and safety

The requirements on systems for low-temperature synthesis provide a high level of quality and safety. Similarly, there are many various requirements on the temperature profile. Principally, with chemical processes in one charge, heating and cooling as well as temperature gradients over a certain time period are needed, resulting in a complicated procedure in terms of energy. In order to be able to acquire and optimize these complex processes and their parameters, it is necessary to pack the process engineering expertise into a powerful controller. The control system must therefore be able to react quickly and to better than one degree of accuracy.



The LAUDA Heating and cooling systems always consist of standardized modules which can be used in all systems in different applications.

The LAUDA Kryopac system usually consists of the modules circulating pump, expansion tank, electric heater and the patented Kryopac heat exchanger.



Secondary circuit system Kryopac KP 600 Ex

Example of a Kryopac system, worked out with the LAUDA module configurator.

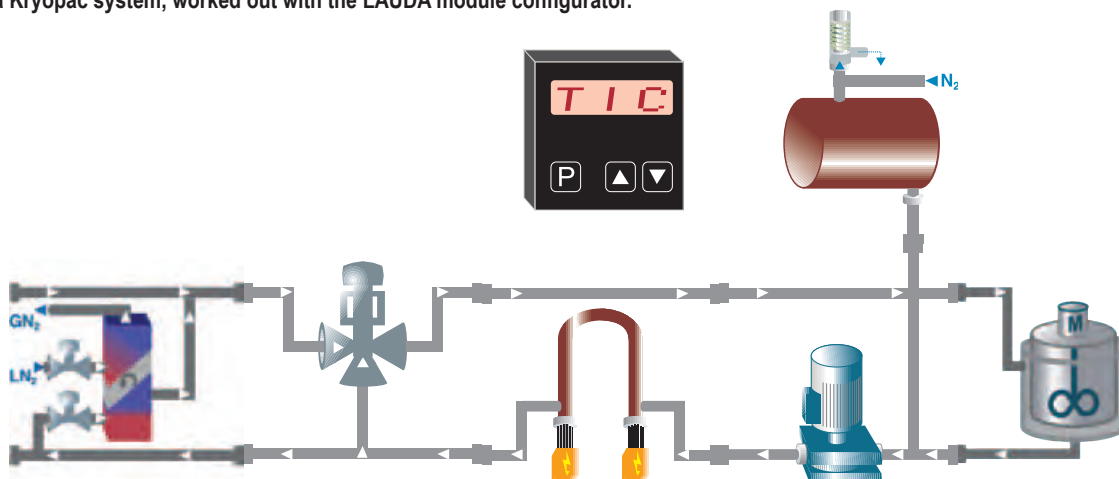

LAUDA Glossary

Actuator

The actuator is an active component of the so-called control circuit. It is controlled through an adjusting command (see Control variable) from the controller (see Temperature controller) and triggers a measure that counteracts the control deviation.

Ambient temperature range

This is the admissible temperature range in which the unit can be operated in accordance with the regulations.

ATEX

Directive 94/9/EC, also known as ATEX 100a, has been issued by the EC in order to harmonize fundamental safety and health requirements for devices, protection systems and components that are provided for use in accordance with the regulations for hazardous areas. This definition includes devices for safety, test and control which are required for use outside hazardous areas with regard to their explosion risks. Directive 94/9/EC is applicable to electrical and non-electrical devices, protection systems and components (electrical and non-electrical operating supplies).

Bus system

see Interface.

Cascade control

see External control.

Component tested safety facilities

As a rule all temperature control units fall within the pressure equipment directive (see DGRL 97/23 EC). Depending on the heat transfer medium and the temperature, the installations have to be equipped with special safety devices, for example safety valves, pressure, temperature or level switches. These devices serve as a protection for the temperature control unit when the admissible limits of the application are exceeded.

Compressor control

see injection control.

Condenser

see refrigerant.

Control deviation

Control deviation is the deviation of the actual value from the preset setpoint. (see control circuit and controller characteristic)

Control circuit

The control circuit is the control section (see Control section) and controller. Sensors and signals, their processing and transmission also form part of the control circuit. For example, transformers, clamps and electric lines.

Control section

Control section is the part of the control circuit to be influenced according to its application. Pipework, sensors and heat transfer areas with their walls and coatings also form part of the control section. Through distances from the test point to the final control element and through inertia at the heat transfer for example, a characteristic response time of a control section arises. Depending on the response time, a control section is classified from 'good' to 'difficult'.

Controller characteristic

Different controllers are distinguished according to their so-called controller characteristic: proportional response (P-controller), integral response (I-controller) and differential response (D-controller). As for temperature controllers, combined characteristics have stood the test. Modern PID-controllers can be perfectly adapted to difficult control sections through freely eligible parameters. They are therefore widely used.

Cooling output

With medium-cooled heat exchangers the cooling output always depends on the temperature difference between the cooling medium and heat transfer fluid. The cooling output reduces at falling outflow temperature and tends to zero when it reaches the cooling medium temperature. With machine-aided cooling the characteristics are similar. The cooling output thus always relates to a definite outflow temperature. At LAUDA the performance data of refrigeration machines is based on cooling water or air with a temperature of 20 °C.

Cooling process

see refrigerant.

Cooling system

see refrigerant.

Delivery head

The delivery head is a theoretical value which is used within the pump characteristics (see Pump characteristic) instead of the feed pressure (see Feed pressure). The advantage is that the delivery head is valid for any given liquid. The feed pressure is then calculated for the respective feed medium by multiplying the density by the delivery head (see Feed pressure).

Evaporator

see refrigerant

Expansion volume/Expansion tank

When heating up the heat transfer medium to the desired operating temperature, the heat transfer medium expands. This expansion volume results from the expansion coefficient, the temperature change and the contents of the unit. The expansion tank installed in the temperature control unit has to collect the expansion volume safely. The assessment of the dimensions of the expansion tank for thermal oils depends on the medium. The following applies for hot water: about 0.8 percent per $\Delta T = 10$ K. The following applies to mineral oils: about 1 percent per $\Delta T = 10$ K. The following applies to silicone oils: about 2 percent per $\Delta T = 10$ K.

External control

If the outflow temperature is not the controlled variable, but it is instead a temperature measured outside the thermostatic unit, then the outflow temperature of the heat transfer fluid is tracked in such a way that the setpoint is reached at the external point. In practice this is achieved via a so-called cascade control (see Cascade control). The so-called "master controller" produces as the control variable (see Control variable) the setpoint for the following slave controller (see Slave controller), which in turn controls the outflow temperature of the heat transfer medium liquid.

Feed pressure

Feed pressure is the manometric pressure measured at the outlet nozzle of a pump or a compressor. With pumps the feed pressure is also given from the pump characteristic (see Delivery head) and the density of the feed medium.

Filling volume

In connection with a LAUDA system, the recommended filling amount of the system (volume) which is required in order to guarantee trouble-free operation, and to allow for expansion or contraction of the system throughout its operating temperature range.

Film temperature

The maximum film temperature, which the manufacturer indicates with reference to organic heat transfer media, describes the temperature at which the heat transfer media begin to decompose. Especially when organic heat transfer media are heated up with the help of electric heaters, attention must be paid to the heat flux values because otherwise the heat transfer medium is destroyed by a high surface or film temperature.

Flow rate

Volume flow of a pump or a compressor. The flow rate depends on the respective operating point and the characteristics (see Pump characteristic) of each component.

GMP/FDA

In processes in which the reaction temperature or the respective temperature control represent a critical quantity, the temperature control unit has to be qualified and validated. Qualification takes place according to the "Good Manufacturing Practice" (GMP). If, for example, pharmaceutical products are produced for the American market, the manufacturing process – and with it the process equipment including the temperature control unit – is subject to the requirements of the American "Food and Drug Administration" (FDA).

Hazard evaluation (HAZOP)

As far as hazard evaluation is concerned, which has to be generated by the operating company, the information relevant for safety from the operating manual of the manufacturer has to be considered. This especially includes: mounting and integration of the temperature control unit into the total system, commissioning, operation, maintenance and inspection and indications for possible improper use, as far as such an application has not already been prevented by the rating/technical measures.

Heater power

With electric heating, the heater power is identical to the power consumption of the built-in electric heaters. It is always the maximum possible heater power and, in the case of electric heating, it remains invariable at all operating temperatures. With medium-heated heat exchangers, the heater power always depends on the temperature difference between heating medium and heat transfer fluid. The heater power reduces at increasing outflow temperatures, and tends to zero when it reaches the heating medium temperature. The applied pump output is helpful but not taken into account.

Heat transfer fluid

These are liquids which supply or dissipate energy at the consumer. The heat carrier is transported to the consumer by the circulating pump on the thermostatic unit. The larger the circulating quantity, the lower the temperature difference at the consumer. The less the temperature difference, the better the control accuracy.

Injection control

With LAUDA process cooling units, the cooling power (see Cooling power) is permanently controlled by adjusting the injection flow (0 - 100 percent). The final control element is a continuously working control valve that is placed in the refrigerant feed line before the evaporator. If several compressors are operated in parallel, an automatic step switch (see Compressor control) ensures energy-saving partial-load operation.

Interface (electrical)

Always serves to exchange data and may be set up on an analogue basis (mostly standard signal 4-20 mA or 0-10 V) or on a digital basis. In the digital area you find the simple serial interfaces (RS 232) or the more powerful, parallel addressable systems for many users (RS 485 or the different industrial bus systems).

Master controller

see External control.

Modular engineering

This describes the modular kit from which any conceivable thermostatic system can be planned and assembled according to a recurring pattern. It saves costs in the planning, implementation, commissioning, documentation and servicing, because each module is itself well-proven. By using modular engineering, a maximum safety standard is achieved.

Monofluid (single fluid) system

This is a heat transfer system which works with only one heat transfer liquid. It is useful when heating, cooling and freezing must be done simultaneously and heating and cooling units are working together.

Overlay pressure/inert gas covering

Through an inert gas covering (nitrogen) on the expansion tank, oxidation of the heat transfer medium and seeping of water vapor from the air can be prevented. If the heat transfer medium is operated below its evaporation point, overlay pressure should be as low as possible (about 0.1 bar), so that when heating up through the reduction of the gas space the pressure increase is not too high. If the heat transfer medium is operated above its evaporation point and atmospheric pressure (1.013 bar), an overlay pressure of at least the respective vapor pressure is necessary in order to safely prevent cavitation. In both cases a safety valve has to be installed on the expansion tank.

Peripheral wheel pump

Peripheral wheel pump is a centrifugal pump with a running wheel that has a so-called 'peripheral' shape. The almost linear characteristics of a peripheral wheel differ fundamentally from the characteristics of a radial running wheel. At highest feed pressure and lowest feed flow rate the highest drive energy is required with the peripheral shape. Peripheral wheel pumps are especially suited for small feed flow rates and high pressures.

Permanent control deviation

In the case of a purely proportional controller there is always a „remaining control deviation“. The control variable will always be proportional to the deviation. There is no adjusting command without a deviation.

Plug & Play modules

Temperature control units and modules arrive at the construction site with clearly defined interfaces, ready for connection, complete with pipework and insulated. They only have to be docked (see Modular engineering).

Pressure Equipment Directive (DGRL 97/23 EC)

Temperature control units are in the control of the pressure equipment directive considered as modules, which are assembled from several pressure devices (expansion tank, pipelines, fittings, safety valve, etc). The fundamental safety requirements for this are described in Annex I of the pressure equipment directive (DGRL). The process of conformity assessment for the module to be applied depends on the category in which the module is classified. This category is determined through the highest category of the respective built-in pressure device. In this connection, parts of equipment with a safety function are ignored. The category that describes the hazard potential depends on the maximum operating pressure, heat transfer medium, content and type of the built-in pressure device. Before the temperature control unit is commissioned, the manufacturer has – according to the operating conditions – to classify the module into a category and to submit it to a process of conformity assessment. The temperature control unit has to be labeled with the CE label and, starting from category II, has to be labeled with the identification number of the named testing laboratory.

Primary side

Denominates primary energy carriers such as vapor, cooling water, air, brine, liquid nitrogen, etc., that have to be connected to the temperature control unit by the customer. These primary energies can be gaseous, vaporous or fluid.

Protection type IP

Pursuant to EN 60529 two numerals assess the electric degree of protection. The first numeral represents the quality of the touch and foreign body protection (dust). The second numeral assesses the protection against water. For example, IP 54 protection signifies dust protection and sealing against splashed water on all sides.

Pump characteristic

This is a diagram that shows the function of the delivery head in relation to the flow rate.

Radial pumps

Radial pumps are centrifugal pumps with a running wheel that has a so-called 'radial' shape. The non-linear characteristics of a radial wheel differ fundamentally from the characteristics of a peripheral wheel. At lowest feed pressure and highest feed flow rate the highest drive energy is required with the radial shape. Standard pumps for the chemical

industry are radial pumps. Radial pumps are especially suited for small feed pressures and high flow rates.

Refrigerant

Operating material of the cooling process that is located in the closed refrigeration system. The compressor sucks it from the evaporator, where it changes to the gaseous condition under heat absorption. On the warmer side of the evaporator the medium cools down due to heat extraction. On the high pressure side of the compressor the cooling medium is liquefied in the condenser/ heat exchanger under heat transfer. The condenser/heat exchanger is water or air-cooled.

Risk analysis

The risk analysis has to be generated by the manufacturer of the temperature control unit. The analysis serves to determine the dangers in connection with the unit with reference to the provided operating conditions. Rating and construction of the temperature control unit take place in consideration of the risk analysis. As to the remaining dangers which cannot be covered through technical solutions, as well as measures required from the operator, the manufacturer has to inform the operator through indications in the operating manual, and if necessary through mounting alert labels on the temperature control unit.

Secondary side/Heat transfer medium side

Designates the side of the temperature control unit from which the heat transfer medium flows. Heat transfer media (thermal oil, water) are chosen according to the operating temperature range and their respective application.

Set value

Adjusting command of the controller that acts on the so-called actuator.

Slave controller

see External control.

Sound pressure level

Quantity for the acoustic emission according to DIN EN ISO 11200. In contrast to the acoustic power level, the pressure level is always assigned to a defined distance. In practice both quantities are stated in dB(A).

System pressure

This is the pressure which is produced by pump pressure, vapor pressure at operating temperature and overlay pressure in the heat transfer medium system. Please pay special attention to the maximum system pressure because all components that have the heat transfer medium flowing through them have to be suitable for the maximum system pressure (see Pressure equipment directive).

Temperature control

Temperature control is taken to mean the controlled supply or extraction of heating or cooling energy to achieve a constant temperature on the consumer.

Temperature controller

A temperature controller is an active component which compares at least one actual temperature value with one setpoint, and depending on the deviation (see Control deviation) outputs an adjusting command (see Control variable). This so-called "adjusting command" acts on the so-called 'final control element' which also actively triggers a measure that acts against the deviation. Temperature controllers can be of purely mechanical design (for example the so-called 'radiator thermostat') or electronic, i.e. analog or digital. Often several operating modes are combined.

Temperature control unit (TCU)

This is a comprehensive term for differently designed heating and cooling systems which in a defined working temperature range can control temperature of the consumer by means of a liquid.

Through-flow cooler

A through-flow cooler is an electrically cooled or otherwise cooled heat exchanger, where a fluid is forced to flow through the system. The cooler mainly serves as a cooler for the fluid that is flowing through. Usually the forced flow is generated by a pump.

Through-flow heater

A through-flow heater is an electrical or otherwise heated heat exchanger, where a fluid is forced through the system. The heater mainly serves as a heater for the fluid that is flowing through. Usually the forced flow is generated by a pump.

Two-circuit cascade refrigeration

This is a cascade connection of two refrigeration systems with cooling mediums (see refrigerant) of different thermodynamic properties. Two-circuit cascades with compression refrigerating processes are used at working temperatures below -50 °C. The first cascade (high-temperature stage) produces temperatures of about -35 °C in the evaporator. On the warm side of the evaporator the cooling medium of the second stage (low-temperature stage) condenses at about -30 °C and vaporizes at about -90 °C, and cools the heat transfer fluid to about -80 °C.

Working temperature range

The temperature range that can be run in the heat transfer medium flow line to the process equipment (outflow).

Our product lines:

Thermostats · Circulation chillers · Water baths
Process cooling systems · Heat transfer systems · Secondary circuit systems
Viscometers · Tensiometers



6-257-e-218.12 · Subject to technical changes.

LAUDA DR. R. WOBSE GMBH & CO. KG
P.O. Box 12 51 · 97912 Lauda-Königshofen · Germany
Phone: +49 (0)9343 503-0 · Fax: +49 (0)9343 503-222
E-mail: info@lauda.de · Internet: www.lauda.de