

**Precise measuring instruments for  
viscosity and surface science**

**Product range 2023 / 2024**

Version 2023-04-01

# Contact Angle Measuring Instruments

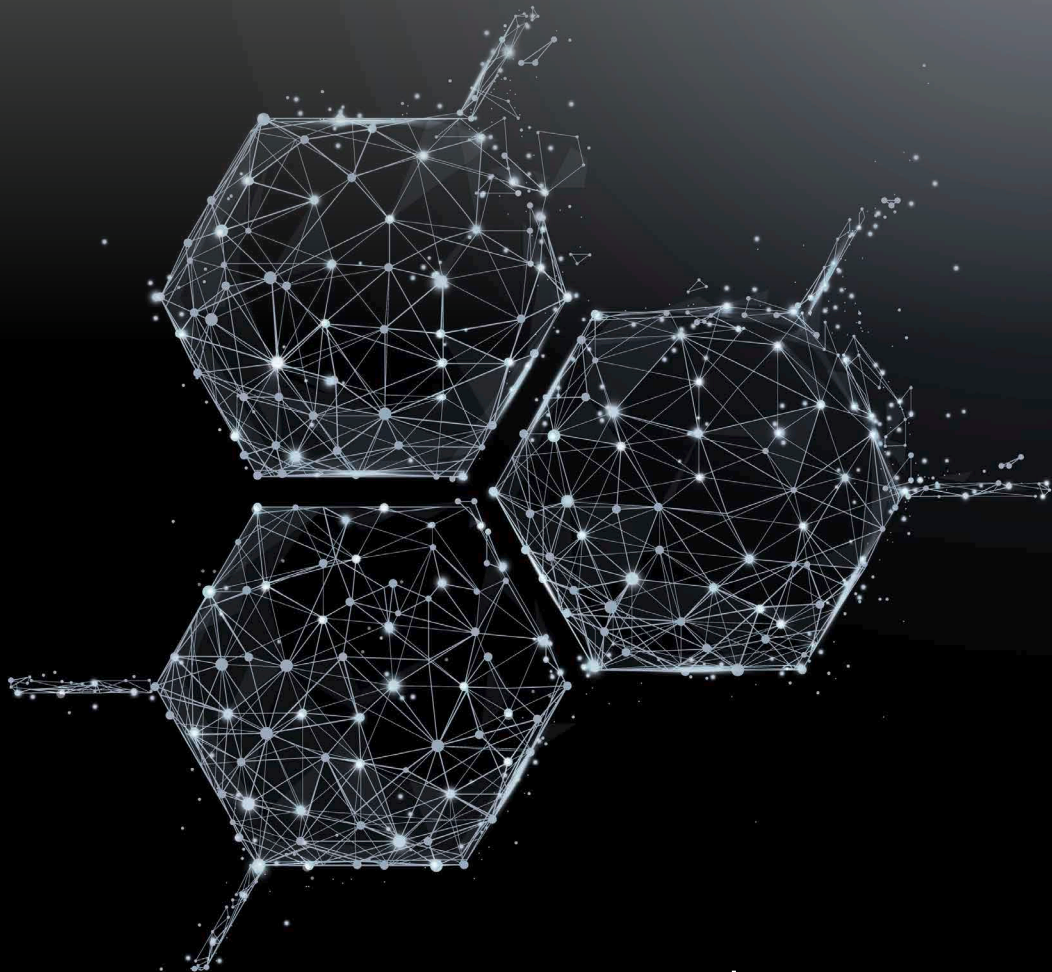

Precise data. Constant values.

## LAUDA Scientific Surface Analyzer

### Precise software for all measuring tasks

The accuracy of contact angle and surface tension measurement based on optical systems is depending to a large extent on the software algorithms. LAUDA Scientific offers you a package for every application, adaptable to different tasks and accessories. Features such as high-speed video recording, predefinable methods, an extensive fluid library and comprehensive adaptability are convincing in practice.

In addition, there are also special methods for very small contact angles and for automatic baseline determination even for difficult surfaces. Various data export formats, focus assistant, evaluation modules for surface energy and control options for sample axes and rotating tables as well as various dosing systems supports you and your application.

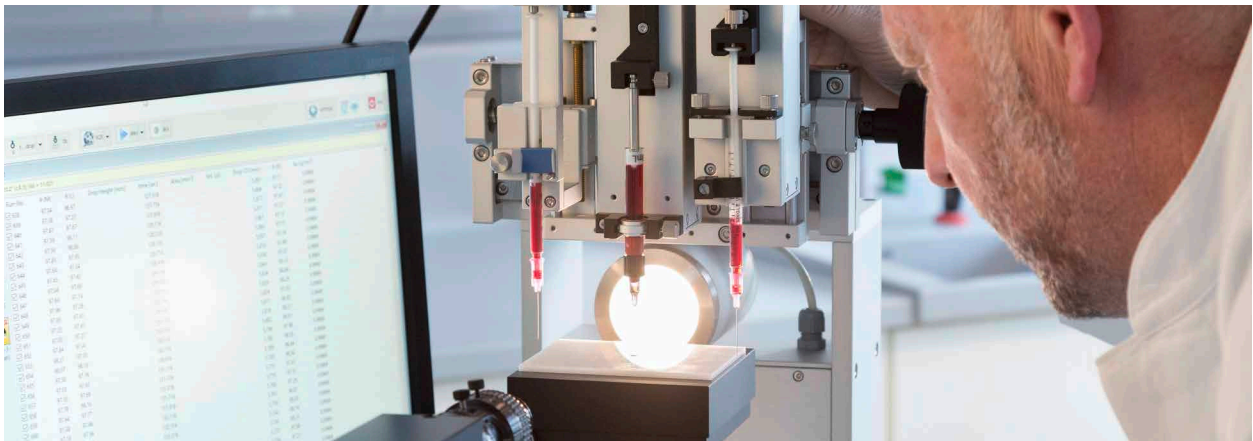

## Software specifications and features

### Contact angle

- || Measurement methods supported: sessile drop, captive bubble, pendant drop
- || Range:  $0^\circ < \theta < 180^\circ$
- || Resolution: 0.01°
- || Precision: better than 0.15° (for ideal drops based on Laplace-Young equation)
- || Computation methods implemented:
  - ◆ Young-Laplace equation for axisymmetric and non-axisymmetric drops)
  - ◆ Conic
  - ◆ iTangent
  - ◆ TrueDrop™
  - ◆ Circle
  - ◆ Height/width
  - ◆ Manual
- || All methods (except manual) run automatically, no user interventions are required
- || Automatic detection of drop deposition & automatic invoking of measurement
- || Automatic baseline detection: before and after drop deposition, with stabilizing capability
- || Curved baseline support for all methods, automatic correction of contact angles due to surface curvature
- || Drop volume determination (before deposition): live tracking
- || Live image computation: single or batch
- || Adjustable frequency / duration for batch computation
- || Video recording support (see below)
- || Computation on image / video files: fully automatically (but allows user interventions if required)
- || Measurement of static, dynamic and equilibrium contact angles
- || Image caching for all calculated live images: they can be reviewed subsequently and recalculated or kept as files if necessary
- || Accurate determination of extreme low contact angle measurement (down to ca. 1°)
- || Template for automatic determination of dynamic contact angles (CAH) and for SFE measurement
- || Besides contact angle values (left / right / mean) computation results include drop geometrical
- || Parameters like volume, surface area, contact diameter and height, drop contact points coordinates, work of adhesion, spreading coefficient, sample tilting angle, etc., depending on computation method applied

## Surface tension / interfacial tension

- || Measurement methods supported: pendant / rising drop / bubble (incl. drop / bubble images with NO Apex), sessile drop (incl. constrained sessile drop)
- || Range: ca. 0.001 ~ 2000 mN/m
- || Resolution :  $\pm 0.01$  mN/m or 0.01 % (pendant / rising drop method)
- || Precision: 0.1 %
- || Incl. (but not limited to) features:
  - ◆ Fully automatic formation of drops (when an automatic dosing unit is used)
  - ◆ Fully automatic IFT measurement (faPDA)
  - ◆ Drop-/Volume-/Area locking capability (when an automatic dosing unit is used)
  - ◆ Dynamic IFT measurement (from ca. 0.1 s)
  - ◆ Enhanced Precision modes (EPM)
- ◆ Fast computing mode
- ◆ Surface / Interface relaxation measurement
- ◆ Automatic determination of liquid / fluid / solid-contact baseline and drop analyzing area
- ◆ Calculation of drop images with NO Apex eliminating restriction of FOV
- ◆ Image caching for all calculated live images: they can be reviewed subsequently and recalculated or kept as files if necessary
- ◆ Support pendant drop quality index
- || Evaluation is based on full-automatic analysis of whole drop profiles in real time. Besides IFT values computation results include drop geometrical parameters like volume, surface area, maximum diameter, height, contact angle, drop quality index etc.

## Surface free energy calculation

- || Surface free energy models supported:
  - ◆ Zisman Plot (critical wetting tension)
  - ◆ Fowkes
  - ◆ Owens-Wendt-Rabel-Kaelble (OWRK)
  - ◆ Extended Fowkes
  - ◆ Wu harmonic mean / Wu geometric mean
  - ◆ Equation-of-State
  - ◆ Lewis acid/base theory
  - ◆ Schultz-1 / -2
- || SFE measurement template
- || Computation can be invoked directly after measurement. No extra input of data is necessary. After computation wetting behavior analysis (WBA™) for the studied surface can be launched straightforwardly. Built-in support for the determination of unknown liquid SFE properties
- || Incl. reporting

## Wetting Behavior Analysis WBA™

- || Based on the chosen SFE model and measurement / computation results, wetting behavior, or adhesion of various liquids (work of adhesion) on a studied solid surface can be modeled and predicted. Different SFE models and full contact angle range ( $0^\circ < \theta < 180^\circ$ ) are supported. Analysis results may be exported in Excel-format.

## Substance database

- || More than 150 common liquids / solids included with about 200 records; editable and extensible

## Video recording and computing

- || Recording speed: adjustable, max. speed camera- & system-dependent
- || Recording time: predefinable or manually controllable. Max. time: NO limitation
- || Recording start: manual or via triggering events
- || Triggering support: leave / enter (adjustable) triggering zone, triggering events
- || Time stamp: with a resolution of 0.1 ms
- || Parameter stamp: dispensing volume, tilting angle etc., device-configuration-dependent
- || Video editing and recording directly to file supported
- || Video instant playback (fileless): supported
- || Video computation: play & computation, whole video or multiple sections; fully automatic (but allowing user-intervention if desired)
- || Video file format: AVI (lossless compression)

## Data center

- || Data display and management:
  - ◆ Organized by measurement task
  - ◆ Drop-based results-data collection and management
  - ◆ Drop-based statistical analysis and data filtering based on robust statistics
  - ◆ Plot with two Y-axes (drop-based settings)
- || Data exportable by clipboard, in Excel / text / bitmap (for plot)-format; single drop-based or whole task-based incl. reporting

## LAUDA Surface Analyzer LSA 50

The LSA 50 is a robust and precise instrument for contact angle measurements and for extremely accurate determination of surface and interfacial tension.

With this versatile measuring capabilities it is the ideal device for research and teaching.

It represents a budget-friendly entry-level device while featuring high-end accuracy. Its large and easy to load sample stage provides a precise z-axis for easy handling.



**LMO 0063**  
**LSA 50 Research**

### Features and benefits:

- || Compact size which requires only small bench space
- || Versatile measuring methods
- || Very easy handling with exchangeable manual dosing system
- || Adjustable platforms for samples and camera
- || Powerful algorithms enable precise drop analysis

Technical features	LSA 50
Lens	1,9x telecentric lens
Camera Type	Camera LCA-5 (USB 3) 1,280x960px max. res., 54 fps
Focus	12 mm fine focus with focus assistant support
Max. sample dimensions (LxWxH)	∞ x 290 x 76 mm
Max. sample weight	15 kg (self-locking w/o clamping)
Sample table dimensions (LxW)	100x100 mm
Travel distance of sample table	Z-direction: 50 mm
Measuring range for contact angles	0–180°
Measuring range for surface and interfacial tensions	0.01...2,000 mN/m Precision: 0.1 %
Power supply	100/240V AC, 50/60 Hz.
Dimensions (WxDxH)	600x160x533 mm
Weight, net	approx. 18 kg

### LMO 0063 LSA 50 Research

For automatic measurement of contact angle, surface tension and surface free energy

#### Included standard components:

- || LSA 50 with 1,7x telecentric lens and LCA-5 camera
- || 1x z axis for manual stage control
- || 1x y/z axis for manual dosing selection / position (max. 1 liquid)
- || 1x camera axis for manual position and tilt control
- || 1x precision micrometer-driven syringe dispensing unit MDU S2 (LMOZ1001)
- || Surface.Meter software (LMOZ9001)

## LAUDA Surface Analyzer LSA 60

The LSA 60 is a robust and precise instrument for contact angle measurements and for extremely accurate determination of surface and interfacial tension using the pendant drop analysis.

It represents a budget-friendly entry-level device while featuring high-end accuracy. Its large and loadable sample stage provides a precise z-axis for easy handling.

Equipped with a micrometer-driven manual dispensing unit it can also be fitted with versatile automatic dosing systems as an option.



**LMO 0060**  
**LSA 60 Basic**

### Features and benefits:

- || Compact size which requires only small bench space
- || Very easy handling with exchangeable dosing system
- || Two axis sample platform for exact positioning with automatic locking
- || Powerful algorithms enable precise drop analysis
- || Expandable with automated dosing systems and tilting table modules

Technical features	LSA 60
Lens	6x zoom lens
Camera type	Camera LCA-3 (USB 3) 1,280x1,024 px max. res., 60 fps
Focus	12 mm fine focus with focus assistant support
Max. sample dimensions (LxWxH)	∞ x 290 x 76 mm
Max. sample weight	15 kg (self-locking w/o clamping)
Sample table dimensions (LxW)	100x100 mm
Travel distance of sample table in X/Y/Z direction	Y: 100 mm (with built-in dust protection cover), Z: 50 mm
Measuring range for contact angles	0–180°
Measuring range for surface and interfacial tensions	0.001...2,000 mN/m Precision: 0.1 %
Power supply	100/240V AC, 50/60 Hz.
Dimensions (WxDxH)	600x160x533 mm
Weight, net	approx. 18kg

### LMO 0060 LSA 60 Basic

For automatic contact angle and surface tension measurements

#### Included standard components:

- || LSA 60 with 6,5x zoom lens and LCA-3 camera
- || 1x y/z axis for manual stage control
- || 1x y/z axis for manual dosing selection / position (max. 2 liquids)
- || 1x Micrometer-driven syringe dispensing unit MDU S1 (LMOZ1000)
- || Surface.Meter software (LMOZ9001)

### LMO 0061 LSA 60 Package 1

Including all standard components of LSA 60 Basic (LMO0060) and additionally 1x automatic direct dispensing unit ADDU 30 (LMOZ1002)



**LMO0061**  
**LSA 60 Package 1**



## LAUDA Surface Analyzer LSA 100

Thanks to the numerous precise adjusting axes and their wide ranges as well as available expansion functionalities / modules, which are of great importance for challenging applications, the LSA 100 is one of the most versatile and flexible devices on the market.

The extremely versatile measuring software Surface.Meter is included as a standard as well as the software module for the determination of surface free energy.

Representing the mid-size version of the LSA family, the LSA 100 is even more expandable and customizable with a wide range of dosing systems, sample stages and other accessories.



**LMO 0100**  
**LSA 100 Basic**

### Features and benefits:

- || Wide range of drop calculation methods for the contact angle, also including the unique TrueDrop method
- || Powerful surface tension measurement
- || Full support of automatic interfacial tension and CMC measurements
- || Up to two different dosing systems integrated (optional non-contact dosing systems and numerous other modules and accessories)

Technical features	LSA 100
Lens	8.7 x zoom lens
Camera Type	Camera LCA-4 (USB 3) 1,920x1,200 px (200 fps) max. res.,
Focus	12 mm fine focus with focus assistant support plus 100 mm focus adjustment axis
Max. sample dimensions (LxWxH)	∞ x 290 x 76 mm
Max. sample weight	15 kg (self-locking w/o clamping)
Sample table dimensions (LxW)	100x100 mm
Travel distance of sample table in X/Y/Z direction	X: 100mm, Y: 100mm (both with built-in dust protection cover), Z: 50mm
Measuring range for contact angles	0–180°
Measuring range for surface and interfacial tensions	0.001...2,000 mN/m Precision: 0.1 %
Power supply	100/240V AC, 50/60 Hz.
Dimensions (WxDxH)	600x160x543 mm
Weight, net	approx. 19kg

The LSA 100 can be expanded using the following modules: all dosing systems max. 2 liquids (p. 69), AZA 50 automatic z-axis (LMOZ3002), all temperature chambers (p. 71), all sample stages (p. 71) and software modules (p. 75).

# LAUDA Surface Analyzer LSA 100

## LMO 0100 LSA 100 Basic

For automatic measurement of contact angle, surface tension and surface free energy

### Included standard components:

- || LSA 100 with 8,7x zoom lens and LCA-4 camera
- || 1x x/y/z axis for manual stage control
- || 1x x/y/z axis for manual dosing selection / position (max. 2 liquids)
- || 1x camera axis for manual position and tilt control
- || 1x Micrometer-driven syringe dispensing unit MDU S1 (LMOZ1000)
- || Surface.Meter software (LMOZ9001)
- || Software module SFE for determination of surface free energy (LMOZ9002)

## LMO 0101 LSA 100 Package 1

Including all standard components of LSA 100 Basic (LMO0100) and additionally 1x automatic direct dispensing unit ADDU 30 (LMOZ1002)

## LMO 0103 LSA 100 Research

For automatic measurement of contact angle, surface tension and surface free energy

### Included standard components:

- || LSA 100 with 1,7x telecentric lens and LCA-4 camera
- || 1x x/y/z axis for manual stage control
- || 1x x/y/z axis for manual dosing selection / position (max. 2 liquids)
- || 1x camera axis for manual position and tilt control
- || 1x Micrometer-driven syringe dispensing unit MDU S1 (LMOZ1000)
- || 1x Automatic direct dispensing unit ADDU 30 (LMOZ1002)
- || Surface.Meter software (LMOZ9001)
- || Software module SFE for determination of surface free energy (LMOZ9002)



LMO 0101  
LSA 100 Package 1



LMO 0103  
Telecentric lens of the LSA 100 Research



## LAUDA Surface Analyzer LSA 200

Thanks to the numerous precise adjusting axes and their wide ranges as well as available expansion functionalities / modules, which are of great importance for challenging applications, the LSA 200 belongs, together with LSA 100, to one of the most versatile and flexible devices on the market.

This is also supported by flexible automation with automatic x/y/z axes for the sample stage.

Optional revolutionary features such as the double view module for simultaneous top and side analysis and measurements on a single drop complete the picture of this top notch surface analyzer.



**LMO 0202**  
**LSA 200 S2**

### Features and benefits:

- || Optional with up to three dosing units and up to six liquids
- || Wide range of drop calculation methods for the contact angle, supplemented by the unique TrueDrop method
- || Powerful surface tension measurement makes mechanical tensiometers obsolete
- || Depending on model up to three different dosing systems integrated (optional non-contact dosing systems and numerous other modules and accessories)

Technical features	LSA 200
Lens	8.7 x zoom lens
Camera Type	Camera LCA-10 (USB3) 1,920x1,200px (170 fps) max. res., and even much more higher rates at lower resolutions
Focus	12 mm fine focus with focus assistant support plus 100 mm focus adjustment axis
Max. sample dimensions (LxWxH)	∞ x 350 x 76 mm
Max. sample weight	15 kg (self-locking w/o clamping)
Sample table dimensions (LxW)	100x100 mm
Travel distance of sample table in X/Y/Z direction	X: 100 mm, Y: 100 mm (both with built-in dust protection cover), Z: 50 mm
Measuring range for contact angles	0 – 180°
Measuring range for surface and interfacial tensions	0.001...2,000 mN/m Precision: 0.1 %
Power supply	100/240V AC, 50/60 Hz.
Dimensions (WxDxH)	750x190x543 mm
Weight, net	approx. 22 kg

The LSA 200 can be expanded using the following modules: all dosing systems max. 3 liquids (p. 69), all automatic sample axes (p. 70), all temperature chambers (p. 71), all sample stages (p. 71) and software modules (p. 75).



## LAUDA Surface Analyzer LSA 200

### LMO 0200 LSA 200

For automatic measurement of contact angle, surface tension and surface free energy

#### Included standard components:

- || LSA 200 with 8,7x zoom lens and LCA-10 camera
- || 1x x/y/z axis for manual stage control
- || 1x x/y/z axis for manual dosing selection / position (max. 3 liquids)
- || 1x camera axis for manual position and tilt control
- || 3x Micrometer-driven syringe dispensing unit MDU S1 (LMOZ1000)
- || Surface.Meter software (LMOZ9001)
- || Software module SFE for determination of surface free energy (LMOZ9002)

### LMO 0202 LSA 200 S2

Including the standard components of LSA 200 (LMO0200), but only with 1x MDU S1 (LMOZ1000) and additionally 2x automatic non-contact direct dispensing unit ADDN 30 (LMOZ1003)



LMO 0202  
LSA 200 S2



# LAUDA Mobile Surface Analyzer LSA MOB

## Special Features:

- || Mobile measuring instrument with innovative top view technology. Suitable for measurements on surfaces with complex topography and on-site inspections
- || Highest precision for any contact angle range due to Young-Laplace fit of the drop. Suitable for all drop sizes and liquids
- || No limits for sample size
- || Surface mapping of the wetting properties with high spatial resolution down to 5 mm
- || Optional robotic systems and automatic sample stages
- || Optional automatic dosing system for measurements both on horizontal and vertical surfaces



LMO 0020  
LSA MOB-M



LMO 0023  
LSA MOB-C

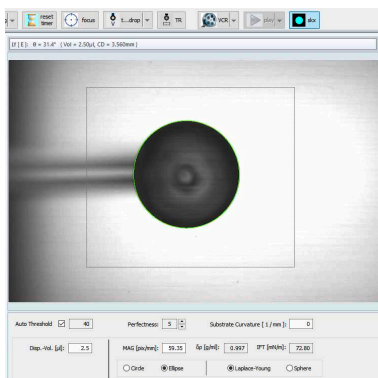

LMOZ9014  
CAD (TV) software module

### LMO 0020 LSA MOB-M

For automatic top view contact angle measurements

#### Included standard components:

- || LSA MOB
- || 1x MOB Micrometer-driven syringe dispensing unit MDU (not available separately)
- || Surface.Meter Elements software (LMOZ9000)

### LMO 0021 LSA MOB-M2

For automatic top view contact angle measurements

#### Included standard components:

- || LSA MOB
- || 2x MOB Micrometer-driven syringe dispensing unit MDU
- || Surface.Meter Elements software (LMOZ9000)

### LMO 0023 LSA MOB-C

For use in combination with conventional LSA units. For automatic contact angle measurements, simultaneously with side and top view

#### Included standard components:

- || LSA MOB-C
- || Software module CAD (TV) (LMOZ9014)

### LMO0024 LSA MOB-P

For process use

## Dosing units for LSA

### LMOZ1000 MDU S1

#### Micrometer-driven syringe dispensing unit MSU S1

For glass and disposable syringes, incl. 1x syringe holder with micrometer and mounting adapter, 20x disposable syringes (2 ml), 1x set of (different sized) needles (3x 20 pcs.) (EZ 524) with dispensing volume resolution of ca. 0.2 µl

### LMOZ1001 MDU S2

#### Precision micrometer-driven syringe dispensing unit MSU S2

For precision glass and disposable syringes (range: 25 mm), incl. 1x syringe holder with micrometer and mounting adapter, 20x disposable syringes (1 ml), 1x set of (different sized) needles (3x 20 pcs.) (EZ 524) with dispensing volume resolution of ca. 0.1 µl

### LMOZ1002 ADDU 30

#### Automatic direct dispensing unit ADDU 30

Incl. 1x gas-tight glass syringe (0.5 ml), 1x set of (different sized) needles (3x 20 pcs.) (EZ 524) with dispensing volume resolution of ca. 0.001 µl and dispensing rates of 1 µl / min...2 ml / min

### LMOZ1003 ADDN 30

#### Automatic non-contact direct dispensing unit ADDN 30

Incl. controller, 1x gas-tight glass syringe (0.5 ml), 1x set of (different sized) needles (3x 20 pcs.) (EZ 524) and disposable syringe tips

### LMOZ1008 ADDD 30

#### Automatic double dispensing unit for 2 liquids

Incl. 2x gas-tight glass syringes (0.5 ml), 1x set of (different sized) needles (3x 20 pcs.) (EZ 524) and software module

### LMOZ1004 ADUV 31

#### Automatic dispensing unit with valve ADUV 31 for 1 liquid

Incl. 1x automatic dosing unit with 3-way valve, 1x gas-tight glass syringe (0.5 ml), 1x tubing set with needle and adaptor and 1x set of (different sized) needles (3x 20 pcs.) (EZ 524)

### LMOZ1005 ADUV 32

#### Automatic dispensing unit with valve ADUV 32 for 2 liquids

Incl. 2x automatic dosing unit with 3-way valve, 2x gas-tight glass syringes (0.5 ml), 2x tubing set with needle and adaptor and 1x set of (different sized) needles (3x 20 pcs.) (EZ 524)

## Piezo dosing unit

### LMOZ1006 PDDU

#### Picoliter drop dispensing unit

Piezo-electro dosing units for picoliter drop size (40 pl...250 pl), incl. controller box, strobe light, liquid vessel, connector set, USB cable and 10x 5 µm filter

### LMOZ1007 Lens upgrade set LSA 100 Micro (for PDDU)

For the analysis of small droplets in combination with PDDU (LMOZ1006), field of view 1...0.17 mm, incl. Mitutoyo 20x microscope lens attachment and 6.5x ultra-zoom converter lens

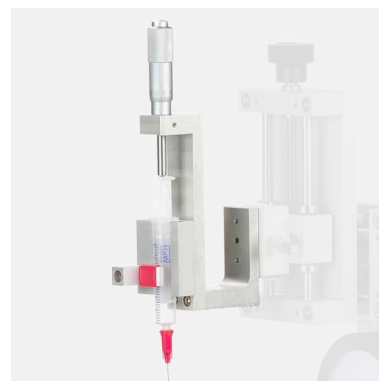

LMOZ1000

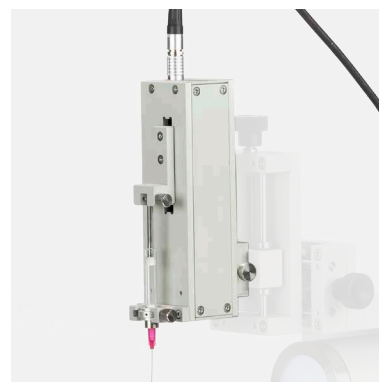

LMOZ1002



LMOZ1006

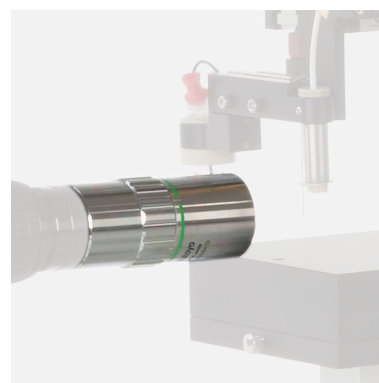

LMOZ1007

## Dosing units for LSA



**LMOZ1010**  
NLDE 30

### Special dosing equipment

#### **LMOZ1010 NLDE 30**

##### **Nanoliter dispensing extender**

Min. droplet volume: ca. 10 nl (water), Max. frequency: ca. 250 Hz, including dispensing valve with holder, controller box, tubing / fittings. Requires ADDU 30 or ADUV 3x, or (manual) dispensing unit MDU S1 / 2

#### **LMOZ1009 TLDM 30**

##### **Triple dosing module manual**

Dosing y-axis and dosing z-axis for usage with three dosing systems. Allows to use 3 dosing units for 3 liquids with the LSA 60 / 100, incl. dosing y-axis and dosing z-axis

#### **LMOZ1011 1DSH-1**

##### **1D-ADDU alignment tool**

Allows precise vertical alignment of the needle for precise Laplace evaluation, can be used with ADDU, ADDD, and ADDN, highly recommended for interfacial tension measurements, surface rheology, DOF and lamella methods

#### **LMOZ1012 3DNH-1**

##### **3D-Needle alignment tool**

## Camera upgrades



**LCA-1**

#### **LMOZ7001 Camera upgrade from LCA-3 to LCA-1**

##### **Camera upgrade for LAUDA Surface Analyzer**

USB 3.0, global shutter,  
Max. resolution 1,280x1,024 @ 170 fps camera speed

#### **LMOZ7002 Camera upgrade from LCA-1 to LCA-2**

##### **Camera upgrade for LAUDA Surface Analyzer**

USB 3.0, global shutter,  
Max. resolution 1,920x1,200 @ 170 fps camera speed

#### **LMOZ7004 Camera upgrade from LCA-3 to LCA-4**

##### **Camera upgrade for LAUDA Surface Analyzer**

USB 3.0, Max. resolution 1,920x1,200 @ 160 fps camera speed  
1,200x60 @ 2,155 fps camera speed

## Automatic sample axes

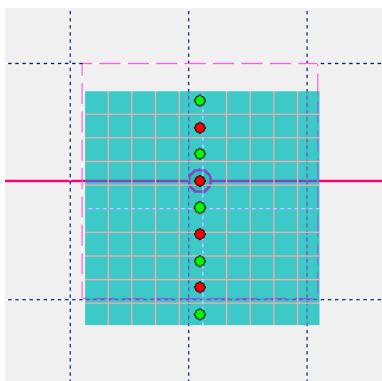

**LMOZ9016**  
ASSM software module

#### **LMOZ3002 AZA 50**

##### **Automatic z axis**

Travel distance vertical 50 mm

#### **LMOZ3004 APA 100**

##### **Automatic x or y axis**

Travel distance horizontal 100 mm  
incl. software module ASSM (LMOZ9016) for Surface.Meter software

#### **LMOZ3005 APA 170**

##### **Automatic x or y axis**

Travel distance vertical 170 mm  
incl. software module ASSM (LMOZ9016) for Surface.Meter software



## Sample chambers

### LMOZ4000 EC 10

#### Environmental chamber

Temperature range  $-10...130^{\circ}\text{C}$ , max. sample size 52x37 mm, for use with external LAUDA thermostat

### LMOZ4001 EC 50

#### Environmental chamber for large samples

Temperature range  $-30...180^{\circ}\text{C}$ , with anti-fogging accessory, max. sample size 95x87x42 mm (LxWxH), for use with external LAUDA thermostat

### LMOZ4003 HTC 350

#### High temperature chamber

With integrated electrical heating, temperature range  $30...350^{\circ}\text{C}$ , max. sample size 60x60 mm

### LMOZ4005 HCU 20

#### Humidity control for EC 10/EC 50

Relative humidity range  $-5...90^{\circ}\text{C}$ , PC controlled

### LMOZ4006 HTC NH

#### Needle heating set

For use with HTC 350 (LMOZ4003) for contact angle measurement and pendant drop, temperature range according to HTC 350

### LMOZ4007 EC 05

#### Syringe temperature module

Temperature range  $-20...180^{\circ}\text{C}$ , for use with external LAUDA thermostat

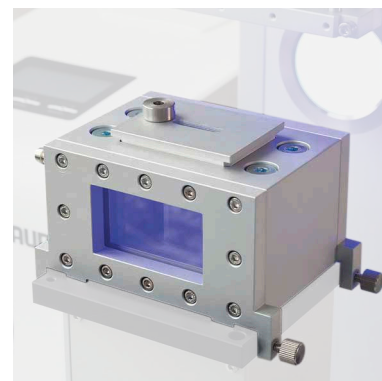

LMOZ4000  
Ec 10



LMOZ4001  
EC 50

## Sample stages

### LMOZ2000 ATS 360

#### Automatic tilting stage

Automatic tilting base assembly, software-controlled, tilting range  $0...360^{\circ}$ , incl. motor-driven tilting base assembly, power supply unit and mounting adapter

### LMOZ2001 RFB 20

#### Retention force balance

For measuring advancing / receding contact angle, retention force and sliding speed, g-range  $0...20\text{m/s}^2$ , incl. RFB 360, software package / support and controller box

### LMOZ2002 STS 10

#### Suction plate

For sample size 10x10cm, for use with vacuum pump (LMOZ2010)

### LMOZ2010 Vacuum pump

For use with STS 10 suction plate (LMOZ2002)

### LMOZ2004 STS 30 Powder sample holder

For sample size 2x2 cm

### LMOZ2005 STS 40 Film holder

For sample size 5x5 cm

### LMOZ2011 STS 80 Film holder

For sample size 8x8 cm

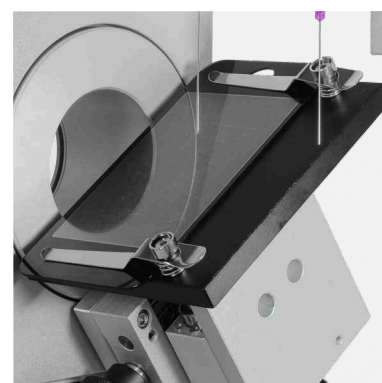

LMOZ2000

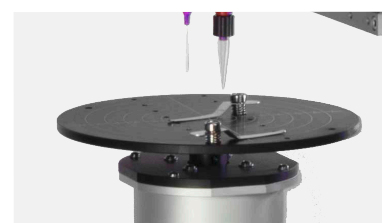

LMOZ2001

## Samples stages



**LMOZ2009**  
**WT200A**

### **LMOZ2006 SFSS Fiber holder**

Incl. adjustment of position and orientation, for fibre size 50 µm...3 mm, with 3D adjustment, max. measurement range 70 mm

### **LMOZ2007 EWA-PF 100 Electro Wetting platform**

For the study of the wetting behavior under various electrical conditions, delivery without power generator

### **LMOZ2008 WT200M Wafer table**

Manual wafer table for 6- and 8-inch wafers, optional for 12-inch wafers, requires LSA 60 or higher.

### **LMOZ2009 WT200A Wafer table**

Automatic wafer table for 6- and 8-inch wafers, optional for 12-inch wafers, requires LSA 60 or higher.

## Modules for advanced analysis

### **LMOZ5000 TVT 10**

#### **Drop volume tensiometer module**

For measuring surface / interfacial tension based on drop volume determination. Emulsifiers reduce the interfacial tension between oil and water, typical dynamic interfacial processes. The TVT 10 module for the LSA series analyses precisely this time dependence for fast to slow processes.

#### **Including:**

Software module (LMOZ9006), set of special needles (EZ 633, EZ 526, EZ 527) and 2x glass cuvette GC 40 (EZ 533).

#### **Hardware requirements:**

LSA 100 or LSA 200 with at least one automatic direct dispensing unit ADDU 30 or ADUV 31 /32.

### **LMOZ5002 CMC 20**

#### **Critical micelle concentration module**

For fully automatic determination of both equilibrium and dynamic critical micelle concentration (CMC) of surfactants based on pendant drop method. In sharp contrast to traditional methods, the optical pendant drop analysis (PDA) method exhibits distinct advantages in almost every aspect regarding accuracy, reliability, convenience, and applicability to solutions containing various kinds of surfactants, as well as the degree of automation.

- || Fully-automatic CMC determination
- || Suitable for measurement of both surface and interfacial tension
- || End-concentration extendable after a measurement is completed
- || Suitable for all kinds of surfactants (also anionic and cationic)
- || Not only static but also dynamic CMC which can be determined at the same time

#### **Including:**

Software module (LMOZ9008), 2x glass cuvette GC 40 with cover (EZ 533), 1x magnetic stirrer incl. stir bar, 1x automatic direct dispensing unit ADUV 32 (LMOZ1005).

#### **Hardware requirements:**

LSA 100 or LSA 200 with at least one automatic direct dispensing unit ADDU 30 or ADUV 31 /32.

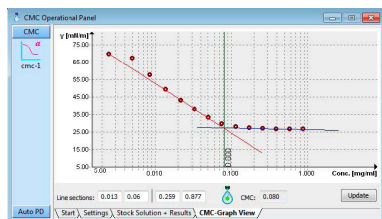

**LMOZ5002**  
**CMC 20**

## Modules for advanced analysis

### LMOZ5007 OEDM 20

#### Oscillating / expanding drop module

This surface / interfacial rheology module uses the pendant drop analysis. The method is based on periodically or abruptly modulating or changing the surface area of a pendant drop and tracking simultaneously the response of its surface or interfacial tension value during the process. By analyzing the shift between drop volume and surface / interfacial tension the surface / interface rheological properties and the dynamic response behavior of the surfactant in a surfactant solution can be studied and measured.

#### Including:

Software module (LMOZ9009), set of special needles (EZ 633, EZ 526, EZ 527), glass cuvette GC 40 (EZ 533) and an automatic direct dispensing unit ADDUX.

#### Hardware requirements:

LSA 100 or LSA 200

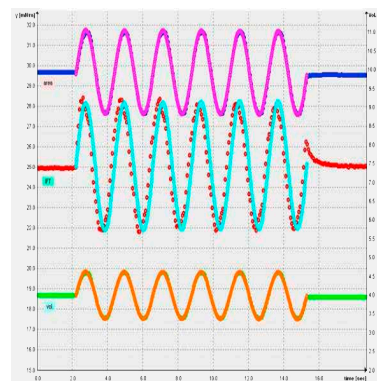

LMOZ5007  
OEDM 20

### LMOZ5006 POW 10

#### Powder / porous wettability module

LAUDA Scientific has developed a novel technique to analyze the wetting behavior using their LSA devices. The method itself is very similar to the Washburn method and it uses actually the same theory and equation.

The measurement itself is very simple. The powder module consists of a powder cell which is connected to a reservoir and the power is kept within that cell by means of a frit. A second, much thinner tube is also connected to this reservoir and serves as a volume level device.

During the measurement a high-precision dosing module pumps the test liquid into the reservoir. The level in the level detection tube is observed with the help of the LSA and precisely evaluated via image analysis. At the very moment when the liquid is touching the powder the change of the liquid level is detected. From that very moment the software keeps the meniscus constant and records the absorbed volume.

By doing so a time-dependent volume is recorded which can be evaluated with the help of the common Washburn theory.

#### Advantages over the traditional Washburn measurement method with a force tensiometer:

- II More dynamic than mechanic measurements to lack of inertia
- II Additional methods like high speed measurements of drops sinking into powder beds or porous material could be realized
- II Identical measurement cell for powder and porous material
- II Hydrophobic materials could be also measured easily in a "powder bed"

#### Including:

Software module (LMOZ9017) and powder module PO-V1.

#### Hardware requirements:

At least one automatic direct dispensing unit ADUV 31 / 32.

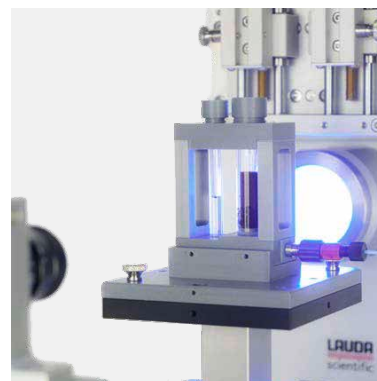

LMOZ5006  
POW 10

### LMOZ5008 Measurement cabinet

Shielding of the LSA against air turbulences, light incidences etc.

## Modules for advanced analysis

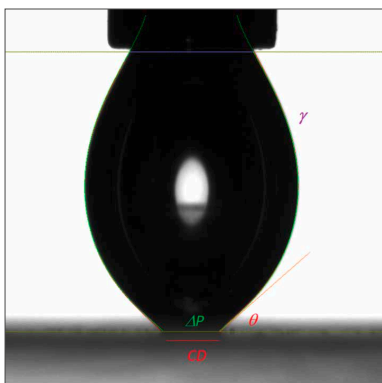

**LMOZ5010**  
DAF-CA

### **LMOZ5009 DAF-IFT**

#### **Drop adhesion force (interfacial tension) module**

Determination of tensile (vertical) adhesion force between a liquid (drop) and solid surface in air, between an air bubble and solid surface in liquid, between a liquid (drop) and solid surface in another liquid phase, between a liquid (drop) and liquid surface in air, between a liquid (drop) and liquid surface in another liquid.

#### **Including:**

Software module (LMOZ9020), automatic z-axis AZA 50 (LMOZ3002) and 1D-ADDU alignment tool 1DSH-1 (LMOZ1011).

#### **Hardware requirements:**

At least one automatic direct dispensing unit ADDU 30 or ADUV 31 / 32.

### **LMOZ5010 DAF-CA**

#### **Drop adhesion force (Contact angle) module**

Determination of advancing and receding contact angle, determination of contact angle (incl. dynamic contact angle like advancing and receding contact angle) for fiber and filaments (e.g. cylindrical wires).

#### **Including:**

Software module (LMOZ9021) and 1D-ADDU alignment tool 1DSH-1 (LMOZ1011).

#### **Hardware requirements:**

At least one automatic direct dispensing unit ADDU 30 or ADUV 31 / 32.

### **LMOZ5011 SWE**

#### **Superwettability evaluation module**

Superwettability High (SWH): Superhydrophobicity for contact angle > 150  
SWL: Superwettability Low (SWL): Superhydrophilicity for contact angle < 5

#### **Including:**

SWE holder, starter kit capillaries, software module (LMOZ9018) and 3D-Needle alignment tool 3DNH-1 (LMOZ1012).

#### **Hardware requirements:**

At least one automatic direct dispensing unit ADDU 30 or ADUV 31 / 32.

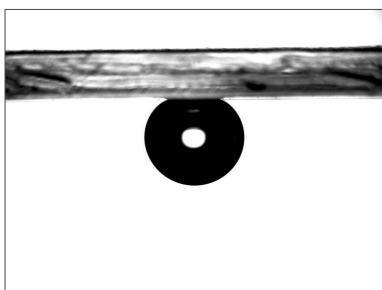

**LMOZ5003**  
CBK 10

### **LMOZ5003 CBK 10**

#### **Captive bubble measurement kit**

For performing captive bubble or sessile drop measurement in another liquid medium with Surface.Meter software (LMOZ9001). Preferred measurement mode for small hydrophilic samples.

#### **Including:**

Set of special needles J-form (EZ 632), 1x glass cuvette GC 40 (EZ 533) and 1x STS 20 sample holder for flat samples, films and contact lenses.



## Software modules overview

**LMOZ9002 SFE**

Determination of surface free energy.

**LMOZ9004 DoF**

Drop on filament module for contact angle measurement on filaments.

**LMOZ9005 faPDA**

Fully automatic pendant drop analysis for surface and interfacial tension measurement (SFT / IFT).

**LMOZ9006 DVT**

Drop volume tensiometry for surface and interfacial tension measurement (SFT / IFT).

**LMOZ9007 IFT (LBM)**

Interfacial tension (IFT) determination of liquids, liquid systems based on liquid meniscus (LBM).

**LMOZ9008 CMC (A)**

Fully automatic determination of critical micelle concentration (CMC) of aqueous surfactant systems, dynamically as well as statically.

**LMOZ9009 OEM 20**

Oscillating / expanding drop module for analysis of rheological properties of interfacial surfaces.

**LMOZ9010 CAD**

Contact angle measurement based on sessile drop method (side view).

**LMOZ9011 IFT (D)**

Surface and interfacial tension measurement (SFT / IFT) angle measurement based on pendant / sessile drop method.

**LMOZ9012 CAM (LBM)**

Contact angle measurement based on analysis of the liquid meniscus.

**LMOZ9014 CAD (TV)**

Contact angle measurement based on sessile drop method (top view).

**LMOZ9015 Duo.Drop**

Analysis of duo (sessile) drops with instant calculation of surface free energy (SFE).

**LMOZ9016 ASSM**

Automatic surface scanning module for fully automatic measurement and scanning of surface properties.

**LMOZ9017 POM**

Wettability of powder / porous samples for the determination of wetting / absorption properties.

**LMOZ9018 SWE**

Measurement of super wettability for the characterization of super-wetting surfaces.

**LMOZ9019 SM4EVAL**

Additional software license for calculation and evaluation.

**LMOZ9020 DAF (IFT)**

Drop adhesion force (DAF) for interfacial tension measurement (IFT).

**LMOZ9021 DAF (CA)**

Drop adhesion force (DAF) for contact angle measurement (CA).

## Dosing accessories for LSA



**EZ 519 | EZ 520 | EZ 521**

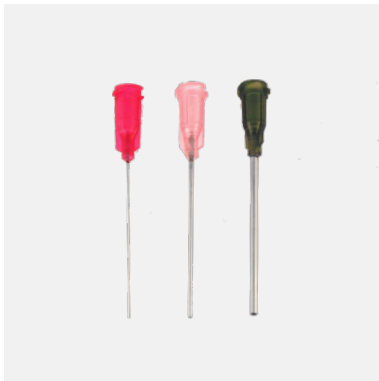

**EZ 524**

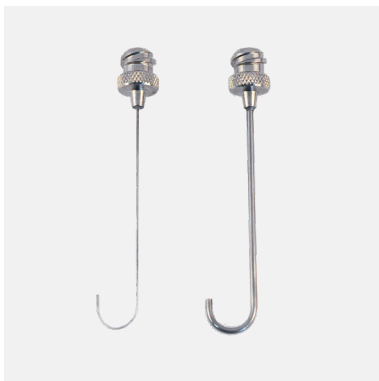

**EZ 632 | EZ 633**

### **EZ 516 ADU DT Disposable tip kit**

Incl. 100x disposable tips of two different sizes and software update, for easy use of disposable syringes together with ADDU 30 (LMOZ1002), ADDN 30 (LMOZ1003), ADUV 31 (LMOZ1004), ADUV 32 (LMOZ1005), max. applicable liquid volume of 100/200µl

### **EZ 817 ADDU Disposable syringe kit**

For easy use of disposable syringes together with ADDU / ADDN, 1 ml

### **EZ 517 LSY 100**

Syringe 100µl, glass

### **EZ 518 LSY 500**

Syringe 500µl, glass

### **EZ 519 LSY 1000**

Syringe 1,000µl, glass

### **EZ 520 LSY 1000D**

Syringe 1,000µl, disposable, 100 pcs.

### **EZ 521 LSY 2000D**

Syringe 2,000µl, disposable, 100 pcs.

### **EZ 776 LNE 027D**

Needle, outer diameter 0.27 mm, disposable, 20 pcs.

### **EZ 674 LNE 050D**

Needle, outer diameter 0.50 mm, disposable, 20 pcs.

### **EZ 834 LNE 050DD**

Needle, outer diameter 0.50 mm, disposable, 20 pcs. for use with ADDD 30 (LMOZ1008)

### **EZ 522 LNE 060D**

Needle, outer diameter 0.60 mm, disposable, 20 pcs.

### **EZ 523 LNE 090D**

Needle, outer diameter 0.90 mm, disposable, 20 pcs.

### **EZ 525 LNE 127D**

Needle, outer diameter 1.27 mm, disposable, 20 pcs.

### **EZ 528 LNE 180D**

Needle, outer diameter 1.80 mm, disposable, 20 pcs.

### **EZ 526 LNE 14 Needle (1.4 mm)**

### **EZ 527 LNE 18 Needle (1.8 mm)**

### **EZ 529 LNE 20 Needle (2.0 mm)**

### **EZ 530 LNE 21 Needle (2.1 mm)**

### **EZ 531 LNE 22 Needle (2.2 mm)**

### **EZ 532 LNE 23 Needle (2.3 mm)**

### **EZ 726 LNE 24 Needle (0.26 mm)**

### **EZ 524 Set of needles**

Incl. 20x LNE 05D (EZ 674), 20x LNE 180D (EZ 528), 20x LNE 090D (EZ 523)

### **EZ 632 LNE 05J**

J-shaped needle, small diameter 0,5 mm

### **EZ 633 LNE 15J**

J-shaped needle, large diameter 1,5 mm

## Dosing accessories for LSA

### EZ 634 LNO 26

Conic nozzle, inner diameter 0.26 mm, length 30 mm, 100 pcs.

### EZ 777 LNO 60

Conic nozzle, inner diameter 0.60 mm, length 30 mm, 100 pcs.

### EZ 635 LNO 84

Conic nozzle, inner diameter 0.84 mm, length 30 mm, 100 pcs.



EZ 635 | EZ 777 | EZ 634

## General accessories for LSA

### EZ 533 GC 40

Cuvette 40mm, optical quality

### EZ 534 GC 25

Cuvette 25 mm, disposable

### EZ 535 GC 50

Cuvette 50 mm, optical quality

### EZ 636 GC 30

Cuvette 30 mm, optical quality,  
compatible with environmental chamber EC 10 (LMOZ4000)



EZ 534 | EZ 533

## Verification standards for contact angle and interfacial tension

A prerequisite for the reliable interpretation of measurement results is certainty about the reliability of the contact angle measuring instrument you are using. For this purpose, we have developed our glass carrier plate with standard drop images.

It contains 12 precise images of different sessile and pendant drop models, combined on a single glass slide. This allows you to verify the performance and reliable accuracy of your measuring instrument independent of individual samples.



EZ 536

### Advantages and Benefits:

- || You verify the function and precision of your LAUDA Scientific contact angle measuring instrument independently of individual samples
- || Easy handling in everyday laboratory work due to a robust and protective housing
- || Cost savings by combining all relevant droplet models on a single measuring body
- || Integration into your gauge management system through own serial number per glass carrier plate

LAUDA  
scientific

Gauge #1

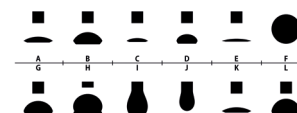

## Additional external temperature equipment for LSA



**L003472**  
LAUDA LOOP L 100

**L003472 LAUDA Scientific LOOP L 100 (230V / 50 (60) Hz)**  
Compact circulation thermostat for use with sample chamber equipment, working temp. range 4...80°C, temperature stability 0.1 ± K, incl. necessary tubings and software module for Surface.Meter software, other power supply variants on request



**L001252**  
LAUDA RE 630 S

**L001252 LAUDA RE 630 S (230V / 50 Hz)**  
Cooling thermostat for use with sample chamber equipment, working temp. range -30...+200°C, temperature stability 0.02 ± K, other power supply variants on request

### Tubings

**RKJ 015 Silicone tubing**  
6 mm inner diameter, price per meter

**LZS 001 Silicone tubing**  
8 mm inner diameter (9 mm insulated), price per meter

**LZS 007 Silicone tubing**  
11 mm inner diameter (9 mm insulated), price per meter

**LZS 018 Viton tubing**  
12 mm inner diameter (10 mm insulated), price per meter for temperatures -20...150°C

**EZS 012 Tubing clamp**  
For silicon and viton tubings (LZS 001, LZS 007, LZS 018)



**LZB 121 | LZB 221 | LZB 321**

### Heat transfer liquids (Silicon oil)

For temperature range -20...180°C

- LZB 116 KRYO 20, 5l**
- LZB 216 KRYO 20, 10l**
- LZB 316 KRYO 20, 20l**

For temperature range -50...120°C

- LZB 121 KRYO 51, 5l**
- LZB 221 KRYO 51, 10l**
- LZB 321 KRYO 51, 20l**





 [www.lauda-scientific.de/en](http://www.lauda-scientific.de/en)

**LAUDA Scientific GmbH**  
Laudaplatz 1  
97922 Lauda-Königshofen  
Germany

Phone: +49 (0) 9343 503-340  
Fax: +49 (0) 9343 503-222  
E-Mail: [info@lauda-scientific.de](mailto:info@lauda-scientific.de)

**LAUDA**  
  
**scientific**